

Antennas • Combining Systems
Power Monitoring • Filters
20 MHz - 2700 MHz

GSA PRICE LIST - July 2008
Contract # GS-35F-0248J

CONTRACT DATES:

February 21, 2009 - February 22, 2014

PRICES HEREIN ARE NET (DISCOUNT DEDUCTED)

Product Information	Section	Page
• Transmitter Combiners - Rack Mount and Panels	1	5-23
• 150 MHz Combiners	1	6-8
• 220 / 350 MHz Combiners	1	9
• 450 MHz Combiners	1	10-14
• 760 MHz Combiners	1	15
• 860 / 900 MHz Combiners	1	16-18
• Ceramic Combiners - Trunking • Cellular • GSM 900	1	19
• Autotune Ceramic Trunking Combiners	1	20
• Pass/Notch Combiners	1	21
• Hybrid Combiners • Couplers	1	22
• Racks and Cabinets	1	23
• Receiver Panels • Splitters	2	24-27
• Receiver Preamplifiers, Relay Panel	2	28
• Receiver Preselectors	2	29-31
• Tower Top Preamplifiers	2	32
• Power Monitoring	3	33
• Wattmeters • Loads • Adaptors	3	34
• Isolators	4	35
• Intermodulation Suppression, THRP	4	36
• High Q Cavities	5	37-40
• Filters - Low Pass • High Pass • Crystal	5	41
• Duplexers - Base and Mobile	6	42-44
• Antennas and Mounting Hardware - Base Station	7	45-51
• Power Dividers	7	52
• Crossband Couplers • Junctions • EZ-Match	7	53
• Cable Assemblies • Connectors	7	54

Contents Copyright © 2008 Telewave, Inc.

Telewave, Inc. 660 Giguere Court San Jose, CA 95133

Toll Free: **1-800-331-3396** Direct: 408-929-4400 Fax: 408-929-4080

TELEWAVE, INC. - TERMS & CONDITIONS - Effective July 2008

TERMS: Prices are F.O.B. Destination if CONUS, Hawaii, Alaska, or Puerto Rico. All other destinations are F.O.B. Seller's plant, San Jose, CA. Domestic packing is included. Export packing or packing that has special requirements will be provided for an extra charge.

PRICES: Prices quoted do not include Federal, State, Local or Excise Taxes. Applicable taxes in effect at the time of shipment will be added unless the buyer has submitted a Certificate of Exemption to the seller. Prices are subject to change without notice. Written price quotations will remain valid for 60 days. The minimum invoice is \$200.00.

ACCEPTANCE: Orders will be valid only when accepted in writing at Seller's office, 660 Giguere Court, San Jose, California. The contract arising therefrom shall be deemed to have been entered into in the State of California, and its interpretation, construction, and the remedies for its enforcement shall be governed in accordance with California Law.

CREDIT: Orders are subject to approval by the seller's credit department. Orders that are not on open account will be shipped prepaid or C.O.D. A confirmed irrevocable letter of credit will be accepted on international orders.

DELIVERY: Delivery times quoted are based on date the order is accepted by the seller. The Seller is not liable for delays or inability to fulfill contractual obligations when the causes thereof are beyond the reasonable control of the seller.

SHIPPING: Shipments will be prepaid if CONUS, Hawaii, Alaska, or Puerto Rico. All other shipments will be collect unless otherwise specified by the buyer and approved by the seller. The buyer's choice of shipper and routing will be used when it is practical. Shipments are routed according to the best judgment of the seller. The seller is not responsible for selecting the least expensive or the fastest routing. Quoted shipping costs are estimates only and not binding on the seller.

CLAIMS: Claims for shortages must be made to the seller within 30 calendar days after date of shipment from the seller's plant. All goods become the property of the buyer upon delivery to the carrier. Claims for goods lost in transit or damage must be made immediately against carrier by the Buyer.

Any request for a change order from the Buyers shall be in writing and no change shall be made pursuant to this clause unless agreed to in writing and signed by Seller and Buyer. If a change causes an increase or decrease in the cost or the time required in the performance of any part of the work, an equitable adjustment shall be made in the contract price and schedule. Seller shall have no obligation to commence any extra or changed work without written agreement as to adjustments to contract price and delivery schedules effective thereby.

Written authorization from Telewave, Inc. must be obtained before returning material. A credit, not greater than 80% of the purchase price of the goods, excluding taxes and shipping, will be allowed. The equipment must be unused and received prepaid in new condition. Any refurbishing of the equipment that is required to return it to an acceptable condition will be charged against the requested credit at our current repair rate. Credit for the returned material will be issued to the original buyer. Cancellation of acknowledged orders by the Buyer will be accepted only upon terms which protect Seller against loss and which are accepted by Seller.

SPECIFICATIONS: All specifications of the seller's products are subject to change without notice. We reserve the right to discontinue the manufacture of any product. We reserve the right to modify any product without the consideration of compatibility of previously manufactured products.

PRODUCT WARRANTY:

Products sold by Telewave, Inc. and covered by this Warranty are warranted to be free from defects in material and workmanship at the time of and for the period specified below after delivery to the Buyer. Seller's entire warranty obligation is limited to making adjustments by repair, replacement, or refunding the purchase price of any product which is returned to the Seller as provided below within the specified period from the date of shipment by the Seller. In no event shall Seller be liable for direct, special, or consequential damages for breach of warranty.

WARRANTY PERIODS:

Antennas and mounting hardware: 5 years
All other products: 1 year

Adjustment will not be allowed for products which have been damaged by lightning, subjected to abuse, improper application or installation, alteration or accident, or negligence in use, storage, transportation or handling. Alteration or removal of the serial number or identification markings voids the Warranty. Seller shall have the right of final determination as to the existence and cause of a defect, whether adjustment will be allowed, and if allowed, whether adjustment will be by repair, replacement, or refund. Where adjustment is not allowed, a charge of 5% of the original purchase price will be made to the Buyer to cover the Seller's cost of inspection and handling.

Shipping and packaging instructions must be obtained from the Seller before products are returned for adjustment. The Buyer will pay for packing, transportation, and transit insurance costs for returned products. The Seller reserves the right to discontinue models at any time or change specifications, design, or price without notice and without incurring any obligation. Products will be returned to the Buyer with transportation cost collect.

Subject to the provisions of its "Patent Indemnity" clause, the Seller also warrants that it has the right to sell its products, that the Buyer shall have and enjoy quiet possession thereof as against any lawful claims existing at the time of the sale by the Seller, and that said products are free from any charge of encumbrance in favor of third persons existing at the time of sale by the Seller.

The foregoing constitutes the Seller's entire warranty, express, implied or statutory with respect to its products and states the full extent of its liability for breach of Warranty and for damages, whether direct, special or consequential resulting from any such breach. No change whatsoever thereto shall be binding upon the seller unless made in writing and signed by a duly authorized representative of the Seller.

RETURN / RMA PROCEDURE:

Please contact Telewave via phone, fax, or email to discuss any product issues with a sales engineer. Many issues occur due to incorrect installation, misconfiguration or irregularities within an existing system, and these can often be resolved at no charge without return of products.

1. Contact Telewave for Technical Assistance at sales@telewave.com or 1-800-331-3396.
2. Telewave will transfer the call or email to the appropriate department.
3. If it is determined that the product(s) should be returned, the Telewave RMA Dept will ask customer to provide billing and return shipping addresses, product model and serial number (if applicable), date of purchase, and where item was purchased.
4. Customer ships product(s) back to Telewave at customer's expense:
 - Write RMA number on the outside of the box(es)
 - Include a description of the problem with the product(s)
 - Ship via a trackable shipping method (UPS, Fedex, etc.)
 - Retain proof of shipment and tracking information
5. Product(s) are received by Telewave and evaluated by the appropriate department. Customer is contacted by RMA department before any charges are incurred.
6. Telewave reserves the right to charge for parts, labor, and freight in the event that the issue is not covered under warranty.
7. Telewave will return original, repaired or replacement item at customer's expense unless covered by warranty.

COMBINER MODEL NUMBER NOMENCLATURE

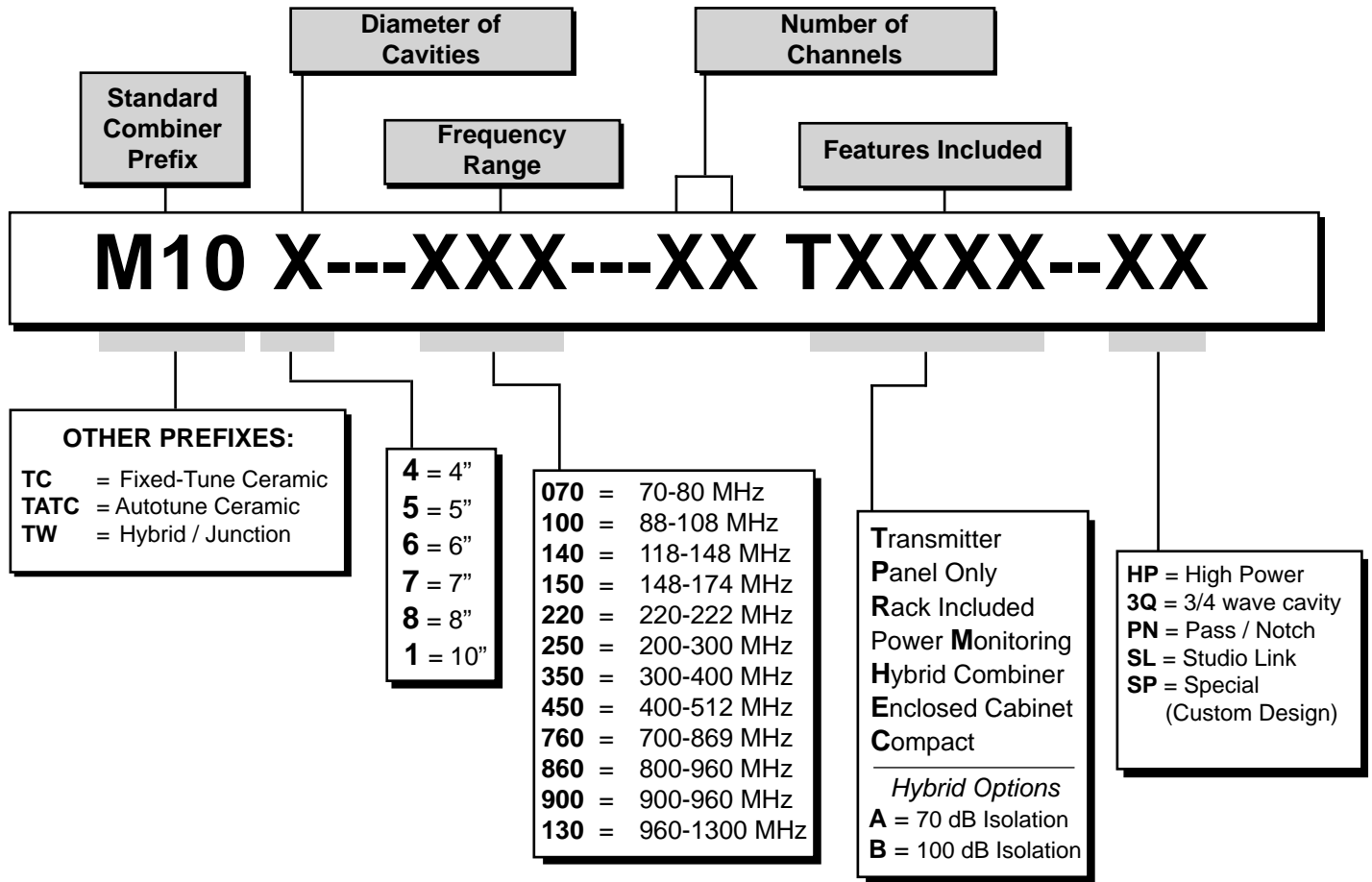

EXAMPLE:

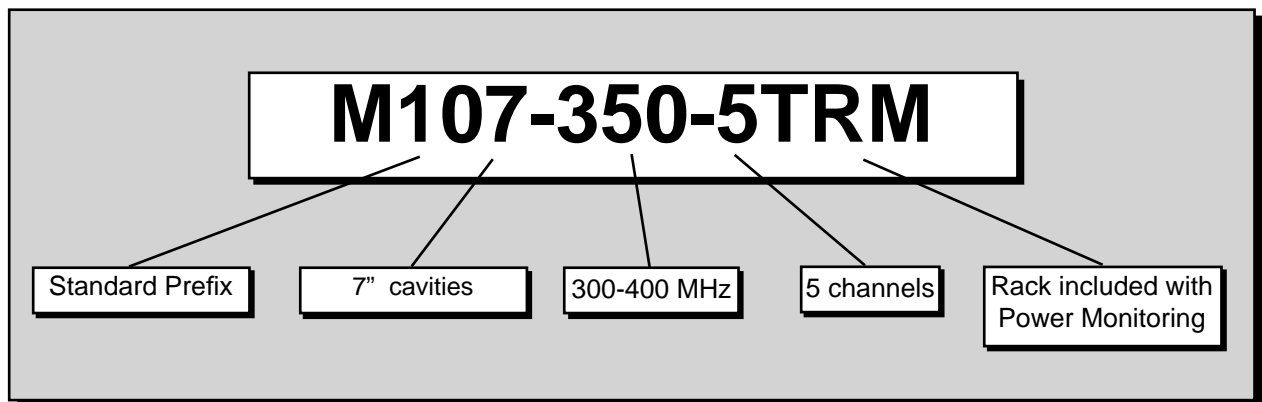

NOTES:

Standard Combiners ship in a 19" Steel Rack, or as panels for 19" rack mounting.
 Self contained combiners with 10" cavities are available in 24" welded steel racks.
 Telewave can build to order. Contact factory for special applications.
 M101-860 combiners utilize 8" cavities.

SECTION 1

M104-150 / M108-150 SERIES

COMPACT EXPANDABLE LOW-LOSS COMBINERS - 148-170 MHz 19" RACK MOUNT PANELS - 4" CAVITIES

Available with up to 4 channels per panel in only 8.75" of rack space. 4" High "Q" cavities.
Expandable with M104-150-1T expansion kits.

MODEL	CH.	DESCRIPTION	FREQ. RANGE	PWR/ CHAN	GSA PRICE
M104-150-1TPC	1	Compact transmitter combiner panel	148-170 MHz	100 watts	\$1,690.80
M104-150-2TPC	2	Compact transmitter combiner panel	148-170 MHz	100 watts	\$2,865.52
M104-150-3TPC	3	Compact transmitter combiner panel	148-170 MHz	100 watts	\$4,040.60
M104-150-4TPC	4	Compact transmitter combiner panel	148-170 MHz	100 watts	\$5,215.39
M104-150-5TPC	5	Compact transmitter combiner - 2 panels	148-170 MHz	100 watts	\$6,831.63
M104-150-6TPC	6	Compact transmitter combiner - 2 panels	148-170 MHz	100 watts	\$8,006.42
M104-150-7TPC	7	Compact transmitter combiner - 2 panels	148-170 MHz	100 watts	\$9,181.21
M104-150-8TPC	8	Compact transmitter combiner - 2 panels	148-170 MHz	100 watts	\$10,356.00
M104-150-1T	1 channel expansion kit, 150 MHz. Must specify frequency and position.				\$1,342.85

EXPANDABLE LOW-LOSS COMBINERS - 148-174 MHz 19" RACK - 8" CAVITIES

Available with up to 8 channels per rack. 8" High "Q" cavities for close spacing. Includes 19" rack, power monitoring, wattmeter panel, and remote keying. Cavities are mounted vertically using rails, or horizontally on a 19" panel.
Expandable with M108-150-1T expansion kits.

MODEL	CH.	DESCRIPTION	FREQ. RANGE	PWR/ CHAN	GSA PRICE
M108-150-1TRM	1	Rack Mounted Transmitter Combiner	148-174 MHz	150 watts	\$3,525.98
M108-150-2TRM	2	Rack Mounted Transmitter Combiner	148-174 MHz	150 watts	\$4,765.90
M108-150-3TRM	3	Rack Mounted Transmitter Combiner	148-174 MHz	150 watts	\$5,961.31
M108-150-4TRM	4	Rack Mounted Transmitter Combiner	148-174 MHz	150 watts	\$7,157.22
M108-150-5TRM	5	Rack Mounted Transmitter Combiner	148-174 MHz	150 watts	\$8,664.98
M108-150-6TRM	6	Rack Mounted Transmitter Combiner	148-174 MHz	150 watts	\$9,860.46
M108-150-7TRM	7	Rack Mounted Transmitter Combiner	148-174 MHz	150 watts	\$11,056.38
M108-150-8TRM	8	Rack Mounted Transmitter Combiner	148-174 MHz	150 watts	\$12,252.07
M108-150-1T	1 channel expansion kit, 150 MHz. Must specify frequency and position.				\$1,748.92

OPTIONS

MODEL	DESCRIPTION	GSA PRICE
DPM	Delete power monitoring, wattmeter panel and remote keying on any combiner	(\$331.15)

SECTION 1

M101-150 SERIES

EXPANDABLE LOW-LOSS COMBINERS - 148-174 MHz 19" RACK - 10" CAVITIES

Available with up to 10 channels per rack. 10" High "Q" cavities for close spacing. Includes 19" rack, power monitoring, wattmeter panel, and remote keying. Expandable with M101-150-1T-19 expansion kits.

MODEL	CH.	DESCRIPTION	FREQ. RANGE	PWR/ CHAN	GSA PRICE
M101-150-1TRM-19	1	Rack Mounted Transmitter Combiner	148-174 MHz	125 watts	\$3,684.24
M101-150-2TRM-19	2	Rack Mounted Transmitter Combiner	148-174 MHz	125 watts	\$4,873.58
M101-150-3TRM-19	3	Rack Mounted Transmitter Combiner	148-174 MHz	125 watts	\$6,063.65
M101-150-4TRM-19	4	Rack Mounted Transmitter Combiner	148-174 MHz	125 watts	\$7,252.98
M101-150-5TRM-19	5	Rack Mounted Transmitter Combiner	148-174 MHz	125 watts	\$8,756.65
M101-150-6TRM-19	6	Rack Mounted Transmitter Combiner	148-174 MHz	125 watts	\$9,946.72
M101-150-7TRM-19	7	Rack Mounted Transmitter Combiner	148-174 MHz	125 watts	\$11,135.98
M101-150-8TRM-19	8	Rack Mounted Transmitter Combiner	148-174 MHz	125 watts	\$12,326.05
M101-150-9TRM-19	9	Rack Mounted Transmitter Combiner	148-174 MHz	125 watts	\$13,515.31
M101-150-10TRM-19	10	Rack Mounted Transmitter Combiner	148-174 MHz	125 watts	\$14,705.38

EXPANSION KIT

MODEL	DESCRIPTION	GSA PRICE
M101-150-1T-19	1 channel expansion kit, 148-174 MHz. Must specify frequency and position. Includes cavity, isolator, power monitor, hardware and cables, as well as factory simulation and tuning to ensure system antenna match.	\$1,855.86

OPTIONS

MODEL	DESCRIPTION	GSA PRICE
TWL-100P	Panel mount 100 Watt Load for Isolator 2nd Stage (per channel)	\$327.27
TBR84-19B	Steel Rack for System Expansion 84" H x 19" W	\$340.94
DPM	Delete power monitoring, wattmeter panel and remote keying on any combiner	(\$331.15)

SECTION 1

M101-150 SERIES

EXPANDABLE LOW-LOSS COMBINERS - 148-174 MHz 24" RACK - 10" CAVITIES

Complete self-contained combining system. Available in 8 or 12 channel racks. Expandable to 12 channels with M101-150-1T expansion kits. Includes 24" welded rack, power monitoring, wattmeter panel, and remote keying.

MODEL	CH.	DESCRIPTION	FREQ. RANGE	PWR/ CHAN	GSA PRICE
M101-150-1TRM	1	24" Rack Mounted Transmitter Combiner	148-174 MHz	150 watts	\$2,786.21
M101-150-2TRM	2	24" Rack Mounted Transmitter Combiner	148-174 MHz	150 watts	\$4,139.51
M101-150-3TRM	3	24" Rack Mounted Transmitter Combiner	148-174 MHz	150 watts	\$5,493.61
M101-150-4TRM	4	24" Rack Mounted Transmitter Combiner	148-174 MHz	150 watts	\$6,847.72
M101-150-5TRM	5	24" Rack Mounted Transmitter Combiner	148-174 MHz	150 watts	\$8,201.82
M101-150-6TRM	6	24" Rack Mounted Transmitter Combiner	148-174 MHz	150 watts	\$9,555.12
M101-150-7TRM	7	24" Rack Mounted Transmitter Combiner	148-174 MHz	150 watts	\$10,908.42
M101-150-8TRM	8	24" Rack Mounted Transmitter Combiner	148-174 MHz	150 watts	\$12,262.53
M101-150-9TRM	9	24" Rack Mounted Transmitter Combiner	148-174 MHz	150 watts	\$13,615.83
M101-150-10TRM	10	24" Rack Mounted Transmitter Combiner	148-174 MHz	150 watts	\$14,970.73
M101-150-11TRM	11	24" Rack Mounted Transmitter Combiner	148-174 MHz	150 watts	\$16,324.03
M101-150-12TRM	12	24" Rack Mounted Transmitter Combiner	148-174 MHz	150 watts	\$17,677.33

EXPANSION KIT

MODEL	DESCRIPTION	GSA PRICE
M101-150-1T	1 channel expansion kit, 148-174 MHz. Must specify frequency and position. Includes cavity, isolator, power monitor, hardware and cables, as well as factory simulation and tuning to ensure system antenna match.	\$1,533.42

OPTIONS

MODEL	DESCRIPTION	GSA PRICE
DPM	Delete power monitoring, wattmeter panel and remote keying on any combiner	(\$331.15)

SECTION 1

M108-220 / M107-350 SERIES

5 CHANNEL LOW-LOSS COMBINER SYSTEM - 220-222 MHz

19" RACK - 8" CAVITIES

Complete combining system with duplexer, preselector and receiver multicoupler.
Includes TBR72-19B rack, power monitoring, wattmeter panel, and remote keying.

MODEL	CH.	DESCRIPTION	FREQ. RANGE	PWR/ CHAN	GSA PRICE
M108-220-5TRDS	5	Rack Mounted Transmitter Combiner	220-222 MHz	125 watts	\$11,830.50

EXPANDABLE LOW-LOSS COMBINERS - 300-400 MHz

19" RACK - 7" CAVITIES

Includes TBR72-19B or TBR84-19B rack, power monitoring, wattmeter panel, and remote keying.
Expandable to 14 channels with M107-350-1T expansion kits.

MODEL	CH.	DESCRIPTION	FREQ. RANGE	PWR/ CHAN	GSA PRICE
M107-350-1TRM	1	Rack Mounted Transmitter Combiner	300-400 MHz	150 watts	\$2,704.99
M107-350-2TRM	2	Rack Mounted Transmitter Combiner	300-400 MHz	150 watts	\$3,973.06
M107-350-3TRM	3	Rack Mounted Transmitter Combiner	300-400 MHz	150 watts	\$5,241.93
M107-350-4TRM	4	Rack Mounted Transmitter Combiner	300-400 MHz	150 watts	\$6,510.80
M107-350-5TRM	5	Rack Mounted Transmitter Combiner	300-400 MHz	150 watts	\$7,779.67
M107-350-6TRM	6	Rack Mounted Transmitter Combiner	300-400 MHz	150 watts	\$9,047.73
M107-350-7TRM	7	Rack Mounted Transmitter Combiner	300-400 MHz	150 watts	\$10,316.60
M107-350-8TRM	8	Rack Mounted Transmitter Combiner	300-400 MHz	150 watts	\$11,585.47
M107-350-9TRM	9	Rack Mounted Transmitter Combiner	300-400 MHz	150 watts	\$12,853.54
M107-350-10TRM	10	Rack Mounted Transmitter Combiner	300-400 MHz	150 watts	\$14,122.41
M107-350-11TRM	11	Rack Mounted Transmitter Combiner	300-400 MHz	150 watts	\$15,390.47
M107-350-12TRM	12	Rack Mounted Transmitter Combiner	300-400 MHz	150 watts	\$16,660.15
M107-350-13TRM	13	Rack Mounted Transmitter Combiner	300-400 MHz	150 watts	\$17,928.21
M107-350-14TRM	14	Rack Mounted Transmitter Combiner	300-400 MHz	150 watts	\$19,197.08
M107-350-1T	1 channel expansion kit, 300-400 MHz. Must specify frequency and position. Includes cavity, isolator, power monitor, hardware and cables, as well as factory simulation and tuning to ensure system antenna match.				\$1,444.97

OPTIONS

MODEL	DESCRIPTION	GSA PRICE
DPM	Delete power monitoring, wattmeter panel and remote keying on any combiner	(\$331.15)

SECTION 1**M106-450 SERIES****COMPACT EXPANDABLE LOW-LOSS COMBINERS - 400-512 MHz
19" RACK MOUNT PANELS - 6" CAVITIES**

Available with up to 4 channels per panel in only 12.25" of rack space. 6" High "Q" cavities.
Expandable with M106-150-1T expansion kits.

MODEL	CH.	DESCRIPTION	FREQ. RANGE	PWR/ CHAN	GSA PRICE
M106-450-1TPC	1	Compact Transmitter Combiner Panel	400-512 MHz	150 watts	\$1,918.58
M106-450-2TPC	2	Compact Transmitter Combiner Panel	400-512 MHz	150 watts	\$3,307.78
M106-450-3TPC	3	Compact Transmitter Combiner Panel	400-512 MHz	150 watts	\$4,697.41
M106-450-4TPC	4	Compact Transmitter Combiner Panel	400-512 MHz	150 watts	\$6,087.04
M106-450-5TPC	5	Compact Transmitter Combiner - 2 Panels	400-512 MHz	150 watts	\$7,476.52
M106-450-6TPC	6	Compact Transmitter Combiner - 2 Panels	400-512 MHz	150 watts	\$8,866.01
M106-450-7TPC	7	Compact Transmitter Combiner - 2 Panels	400-512 MHz	150 watts	\$10,256.30
M106-450-8TPC	8	Compact Transmitter Combiner - 2 Panels	400-512 MHz	150 watts	\$11,645.56
M106-450-9TPC	9	Compact Transmitter Combiner - 3 Panels	400-512 MHz	150 watts	\$13,035.19
M106-450-10TPC	10	Compact Transmitter Combiner - 3 Panels	400-512 MHz	150 watts	\$14,424.75
M106-450-11TPC	11	Compact Transmitter Combiner - 3 Panels	400-512 MHz	150 watts	\$15,814.23
M106-450-12TPC	12	Compact Transmitter Combiner - 3 Panels	400-512 MHz	150 watts	\$17,203.72

EXPANSION KIT

MODEL	DESCRIPTION	GSA PRICE
M106-450-1T	1 channel expansion kit, 400-512 MHz. Must specify frequency and position. Includes cavity, isolator, power monitor, hardware and cables, as well as factory simulation and tuning to ensure system antenna match.	\$1,748.92

SECTION 1

M107-450 SERIES

EXPANDABLE LOW-LOSS COMBINERS - 400-512 MHZ

19" RACK - 7" CAVITIES

Available with up to 10 channels per rack. Expandable with M107-450-1T expansion kits.
Includes 19" rack, power monitoring, wattmeter panel, and remote keying.

MODEL	CH.	DESCRIPTION	FREQ. RANGE	PWR/ CHAN	GSA PRICE
M107-450-1TRM	1	Compact Transmitter Combiner Panel	400-512 MHz	150 watts	\$3,272.69
M107-450-2TRM	2	Compact Transmitter Combiner Panel	400-512 MHz	150 watts	\$4,807.71
M107-450-3TRM	3	Compact Transmitter Combiner Panel	400-512 MHz	150 watts	\$6,341.94
M107-450-4TRM	4	Compact Transmitter Combiner Panel	400-512 MHz	150 watts	\$7,876.96
M107-450-5TRM	5	Compact Transmitter Combiner - 2 Panels	400-512 MHz	150 watts	\$9,410.89
M107-450-6TRM	6	Compact Transmitter Combiner - 2 Panels	400-512 MHz	150 watts	\$10,945.99
M107-450-7TRM	7	Compact Transmitter Combiner - 2 Panels	400-512 MHz	150 watts	\$12,480.36
M107-450-8TRM	8	Compact Transmitter Combiner - 2 Panels	400-512 MHz	150 watts	\$14,015.46
M107-450-9TRM	9	Compact Transmitter Combiner - 3 Panels	400-512 MHz	150 watts	\$15,549.69
M107-450-10TRM	10	Compact Transmitter Combiner - 3 Panels	400-512 MHz	150 watts	\$17,084.71
M107-450-1T	1 channel expansion kit, 400-512 MHz. Must specify frequency and position. Includes cavity, isolator, power monitor, hardware and cables, as well as factory simulation and tuning to ensure system antenna match.				\$1,748.92

OPTIONS

MODEL	DESCRIPTION	GSA PRICE
DPM	To delete power monitoring, wattmeter panel and remote keying on any combiner	(\$331.15)

EXPANDABLE LOW-LOSS COMBINER PANELS - 400-512 MHZ

19" RACK MOUNT PANELS - 7" CAVITIES

Available with 4 or 6 Channels per panel. Expandable with M107-450-1T expansion kits.

MODEL	CH.	DESCRIPTION	FREQ. RANGE	PWR/ CHAN	GSA PRICE
M107-450-1TP	1	Compact Transmitter Combiner Panel	400-512 MHz	150 watts	\$1,918.58
M107-450-2TP	2	Compact Transmitter Combiner Panel	400-512 MHz	150 watts	\$3,307.04
M107-450-3TP	3	Compact Transmitter Combiner Panel	400-512 MHz	150 watts	\$4,697.41
M107-450-4TP	4	Compact Transmitter Combiner Panel	400-512 MHz	150 watts	\$6,087.04
M107-450-5TP	5	Compact Transmitter Combiner - 2 Panels	400-512 MHz	150 watts	\$7,476.52
M107-450-6TP	6	Compact Transmitter Combiner - 2 Panels	400-512 MHz	150 watts	\$8,866.01
M107-450-7TP	7	Compact Transmitter Combiner - 2 Panels	400-512 MHz	150 watts	\$10,256.30
M107-450-8TP	8	Compact Transmitter Combiner - 2 Panels	400-512 MHz	150 watts	\$11,645.56
M107-450-9TP	9	Compact Transmitter Combiner - 3 Panels	400-512 MHz	150 watts	\$13,035.19
M107-450-10TP	10	Compact Transmitter Combiner - 3 Panels	400-512 MHz	150 watts	\$14,424.75
M107-450-1T	1 channel expansion kit, 400-512 MHz. Must specify frequency and position.				\$1,748.92

SECTION 1**M108-450 SERIES****EXPANDABLE LOW-LOSS COMBINERS - 400-512 MHz****19" RACK - 8" CAVITIES**

Available with up to 10 channels per rack. Includes 19" rack, power monitoring, wattmeter panel, and remote keying. Expandable with M108-450-1T expansion kits.

MODEL	CH.	DESCRIPTION	FREQ. RANGE	PWR/ CHAN	GSA PRICE
M108-450-1TRM	1	Rack Mounted Transmitter Combiner	400-512 MHz	150 watts	\$3,946.52
M108-450-2TRM	2	Rack Mounted Transmitter Combiner	400-512 MHz	150 watts	\$5,163.05
M108-450-3TRM	3	Rack Mounted Transmitter Combiner	400-512 MHz	150 watts	\$6,378.71
M108-450-4TRM	4	Rack Mounted Transmitter Combiner	400-512 MHz	150 watts	\$7,595.53
M108-450-5TRM	5	Rack Mounted Transmitter Combiner	400-512 MHz	150 watts	\$8,811.33
M108-450-6TRM	6	Rack Mounted Transmitter Combiner	400-512 MHz	150 watts	\$10,027.86
M108-450-7TRM	7	Rack Mounted Transmitter Combiner	400-512 MHz	150 watts	\$11,243.51
M108-450-8TRM	8	Rack Mounted Transmitter Combiner	400-512 MHz	150 watts	\$12,460.33
M108-450-9TRM	9	Rack Mounted Transmitter Combiner	400-512 MHz	150 watts	\$13,676.13
M108-450-10TRM	10	Rack Mounted Transmitter Combiner	400-512 MHz	150 watts	\$14,892.66
M108-450-1T	1 channel expansion kit, 400-512 MHz. Must specify frequency and position. Includes cavity, isolator, power monitor, hardware and cables, as well as factory simulation and tuning to ensure system antenna match.				\$1,748.92
DPM	To delete power monitoring, wattmeter panel and remote keying on any combiner				(\$331.15)

EXPANDABLE LOW-LOSS COMBINERS - 400-512 MHz**19" RACK - 8" 3/4 WAVE CAVITIES**

Available with up to 8 channels per rack. 3/4 wave cavities for close spacing. Includes 19" rack, power monitoring, wattmeter panel, and remote keying. Cavities are mounted vertically using rails, or horizontally on a 19" panel. Expandable with M108-150-1T-3Q expansion kits.

MODEL	CH.	DESCRIPTION	FREQ. RANGE	PWR/ CHAN	GSA PRICE
M108450-1TRM3Q	1	Rack Mounted Transmitter Combiner	400-512 MHz	150 watts	\$3,525.98
M108450-2TRM3Q	2	Rack Mounted Transmitter Combiner	400-512 MHz	150 watts	\$4,765.90
M108450-3TRM3Q	3	Rack Mounted Transmitter Combiner	400-512 MHz	150 watts	\$5,961.31
M108450-4TRM3Q	4	Rack Mounted Transmitter Combiner	400-512 MHz	150 watts	\$7,157.22
M108450-5TRM3Q	5	Rack Mounted Transmitter Combiner	400-512 MHz	150 watts	\$8,664.98
M108450-6TRM3Q	6	Rack Mounted Transmitter Combiner	400-512 MHz	150 watts	\$9,860.46
M108450-7TRM3Q	7	Rack Mounted Transmitter Combiner	400-512 MHz	150 watts	\$11,056.38
M108450-8TRM3Q	8	Rack Mounted Transmitter Combiner	400-512 MHz	150 watts	\$12,252.07
M108-450-1T-3Q	1 channel expansion kit, 400-512 MHz, 3/4 wave. Specify frequency and position. Includes cavity, isolator, power monitor, hardware and cables, and factory simulation and tuning to ensure system antenna match.				\$1,748.92

SECTION 1

M101-450 SERIES

EXPANDABLE LOW-LOSS COMBINERS - 400-512 MHZ

19" RACK - 10" CAVITIES

Available with up to 10 channels per rack. Includes 19" rack, power monitoring, wattmeter panel, and remote keying. Expandable with M101-450-1T-19 expansion kits.

MODEL	CH.	DESCRIPTION	FREQ. RANGE	PWR/ CHAN	GSA PRICE
M101450-1TRM19	1	Rack Mounted Transmitter Combiner	400-512 MHz	150 watts	\$3,577.44
M101450-2TRM19	2	Rack Mounted Transmitter Combiner	400-512 MHz	150 watts	\$4,731.03
M101450-3TRM19	3	Rack Mounted Transmitter Combiner	400-512 MHz	150 watts	\$5,886.74
M101450-4TRM19	4	Rack Mounted Transmitter Combiner	400-512 MHz	150 watts	\$7,041.50
M101450-5TRM19	5	Rack Mounted Transmitter Combiner	400-512 MHz	150 watts	\$8,501.53
M101450-6TRM19	6	Rack Mounted Transmitter Combiner	400-512 MHz	150 watts	\$9,657.24
M101450-7TRM19	7	Rack Mounted Transmitter Combiner	400-512 MHz	150 watts	\$10,811.93
M101450-8TRM19	8	Rack Mounted Transmitter Combiner	400-512 MHz	150 watts	\$11,967.20
M101450-9TRM19	9	Rack Mounted Transmitter Combiner	400-512 MHz	150 watts	\$13,121.30
M101450-10TRM19	10	Rack Mounted Transmitter Combiner	400-512 MHz	150 watts	\$14,276.80
M101-450-1T	1 channel expansion kit, 400-512 MHz. Must specify frequency and position. Includes cavity, isolator, power monitor, hardware and cables, as well as factory simulation and tuning to ensure system antenna match.				\$1,444.97
DPM	To delete power monitoring, wattmeter panel and remote keying on any combiner				(\$331.15)

EXPANDABLE CLOSE SPACING LOW-LOSS COMBINERS - 400-512 MHZ

19" RACK - 10" 3/4 WAVE CAVITIES

Available with up to 10 channels per rack. 3/4 wave cavities for close spacing. Includes 19" rack, power monitoring, wattmeter panel, and remote keying. Expandable with M101-450-1T-19 expansion kits.

MODEL	CH.	DESCRIPTION	FREQ. RANGE	PWR/ CHAN	GSA PRICE
M101450-1TRM193Q	1	Rack Mounted Transmitter Combiner	400-512 MHz	125 watts	\$3,684.24
M101450-2TRM193Q	2	Rack Mounted Transmitter Combiner	400-512 MHz	125 watts	\$4,873.58
M101450-3TRM193Q	3	Rack Mounted Transmitter Combiner	400-512 MHz	125 watts	\$6,063.65
M101450-4TRM193Q	4	Rack Mounted Transmitter Combiner	400-512 MHz	125 watts	\$7,252.98
M101450-5TRM193Q	5	Rack Mounted Transmitter Combiner	400-512 MHz	125 watts	\$8,756.65
M101450-6TRM193Q	6	Rack Mounted Transmitter Combiner	400-512 MHz	125 watts	\$9,946.72
M101450-7TRM193Q	7	Rack Mounted Transmitter Combiner	400-512 MHz	125 watts	\$11,135.98
M101450-8TRM193Q	8	Rack Mounted Transmitter Combiner	400-512 MHz	125 watts	\$12,326.05
M101450-9TRM193Q	9	Rack Mounted Transmitter Combiner	400-512 MHz	125 watts	\$13,515.31
M101450-10TRM193Q	10	Rack Mounted Transmitter Combiner	400-512 MHz	125 watts	\$14,705.38
M101450-1T3Q	1 channel expansion kit, 400-512 MHz, 3/4 wave. Specify frequency / position.				\$1,855.86

SECTION 1**M101-450 SERIES****EXPANDABLE 450 MHz LOW-LOSS COMBINERS - 400-512 MHz
24" RACK - 10" CAVITIES**

Available in 8 or 12 channel racks. Expandable to 12 channels with M101-450-1T expansion kits.
Includes 24" welded rack, power monitoring, wattmeter panel, and remote keying.

MODEL	CH.	DESCRIPTION	FREQ. RANGE	PWR/ CHAN	GSA PRICE
M101-450-1TRM	1	24" Rack Mounted Transmitter Combiner	400-512 MHz	150 watts	\$2,704.99
M101-450-2TRM	2	24" Rack Mounted Transmitter Combiner	400-512 MHz	150 watts	\$3,973.06
M101-450-3TRM	3	24" Rack Mounted Transmitter Combiner	400-512 MHz	150 watts	\$5,241.93
M101-450-4TRM	4	24" Rack Mounted Transmitter Combiner	400-512 MHz	150 watts	\$6,510.80
M101-450-5TRM	5	24" Rack Mounted Transmitter Combiner	400-512 MHz	150 watts	\$7,779.67
M101-450-6TRM	6	24" Rack Mounted Transmitter Combiner	400-512 MHz	150 watts	\$9,047.73
M101-450-7TRM	7	24" Rack Mounted Transmitter Combiner	400-512 MHz	150 watts	\$10,316.60
M101-450-8TRM	8	24" Rack Mounted Transmitter Combiner	400-512 MHz	150 watts	\$11,585.47
M101-450-9TRM	9	24" Rack Mounted Transmitter Combiner	400-512 MHz	150 watts	\$12,853.54
M101-450-10TRM	10	24" Rack Mounted Transmitter Combiner	400-512 MHz	150 watts	\$14,122.41
M101-450-11TRM	11	24" Rack Mounted Transmitter Combiner	400-512 MHz	150 watts	\$15,390.47
M101-450-12TRM	12	24" Rack Mounted Transmitter Combiner	400-512 MHz	150 watts	\$16,660.15
M101-450-1T	1 channel expansion kit, 400-512 MHz. Specify frequency and position. Includes cavity, isolator, power monitor, mounting hardware and cables, as well as factory simulation and tuning to ensure system antenna match.				\$1,444.97
DPM	To delete power monitoring, wattmeter panel and remote keying on any combiner				(\$331.15)

**EXPANDABLE CLOSE SPACING LOW-LOSS COMBINERS - 400-512 MHz
24" RACK - 10" 3/4 WAVE CAVITIES**

Available in 8 or 12 channel racks. Includes 24" welded rack, power monitoring, wattmeter panel, and remote keying.

MODEL	CH.	DESCRIPTION	FREQ. RANGE	PWR/ CHAN	GSA PRICE
M101450-1TRM3Q	1	24" Rack Mounted Transmitter Combiner	400-512 MHz	150 watts	\$3,371.37
M101450-2TRM3Q	2	24" Rack Mounted Transmitter Combiner	400-512 MHz	150 watts	\$5,008.74
M101450-3TRM3Q	3	24" Rack Mounted Transmitter Combiner	400-512 MHz	150 watts	\$6,645.89
M101450-4TRM3Q	4	24" Rack Mounted Transmitter Combiner	400-512 MHz	150 watts	\$8,283.69
M101450-5TRM3Q	5	24" Rack Mounted Transmitter Combiner	400-512 MHz	150 watts	\$9,920.99
M101450-6TRM3Q	6	24" Rack Mounted Transmitter Combiner	400-512 MHz	150 watts	\$11,557.84
M101450-7TRM3Q	7	24" Rack Mounted Transmitter Combiner	400-512 MHz	150 watts	\$13,195.28
M101450-8TRM3Q	8	24" Rack Mounted Transmitter Combiner	400-512 MHz	150 watts	\$14,832.43
M101450-9TRM3Q	9	24" Rack Mounted Transmitter Combiner	400-512 MHz	150 watts	\$16,469.43
M101450-10TRM3Q	10	24" Rack Mounted Transmitter Combiner	400-512 MHz	150 watts	\$18,106.72
M101450-11TRM3Q	11	24" Rack Mounted Transmitter Combiner	400-512 MHz	150 watts	\$19,743.58
M101450-12TRM3Q	12	24" Rack Mounted Transmitter Combiner	400-512 MHz	150 watts	\$21,381.02
M101450-1T3Q	1 channel expansion kit, 400-512 MHz, 3/4 wave. Specify frequency / position.				\$1,855.86

SECTION 1

M107-760 SERIES

EXPANDABLE LOW-LOSS COMBINERS - 700-800 MHz 19" RACK - 7" CAVITIES

Includes TBR72-19B or TBR84-19B rack, power monitoring, wattmeter panel, and remote keying. Expandable to 14 channels with M107-760-1T expansion kits. Combining solutions are available to integrate 763-869 MHz channels into a single rack. Contact Telewave for more information.

MODEL	CH.	DESCRIPTION	FREQ. RANGE	PWR/ CHAN	GSA PRICE
M107-760-1TRM	1	Rack Mounted Transmitter Combiner	700-800 MHz	150 watts	\$2,704.99
M107-760-2TRM	2	Rack Mounted Transmitter Combiner	700-800 MHz	150 watts	\$3,973.06
M107-760-3TRM	3	Rack Mounted Transmitter Combiner	700-800 MHz	150 watts	\$5,241.93
M107-760-4TRM	4	Rack Mounted Transmitter Combiner	700-800 MHz	150 watts	\$6,510.80
M107-760-5TRM	5	Rack Mounted Transmitter Combiner	700-800 MHz	150 watts	\$7,779.67
M107-760-6TRM	6	Rack Mounted Transmitter Combiner	700-800 MHz	150 watts	\$9,047.73
M107-760-7TRM	7	Rack Mounted Transmitter Combiner	700-800 MHz	150 watts	\$10,316.60
M107-760-8TRM	8	Rack Mounted Transmitter Combiner	700-800 MHz	150 watts	\$11,585.47
M107-760-9TRM	9	Rack Mounted Transmitter Combiner	700-800 MHz	150 watts	\$12,853.54
M107-760-10TRM	10	Rack Mounted Transmitter Combiner	700-800 MHz	150 watts	\$14,122.41
M107-760-11TRM	11	Rack Mounted Transmitter Combiner	700-800 MHz	150 watts	\$15,390.47
M107-760-12TRM	12	Rack Mounted Transmitter Combiner	700-800 MHz	150 watts	\$16,660.15
M107-760-13TRM	13	Rack Mounted Transmitter Combiner	700-800 MHz	150 watts	\$17,928.21
M107-760-14TRM	14	Rack Mounted Transmitter Combiner	700-800 MHz	150 watts	\$19,197.08

EXPANSION KIT

MODEL	DESCRIPTION	GSA PRICE
M107-760-1T	1 channel expansion kit, 700-800 MHz. Must specify frequency and position. Includes cavity, isolator, power monitor, hardware and cables, as well as factory simulation and tuning to ensure system antenna match.	\$1,444.97

OPTIONS

MODEL	DESCRIPTION	GSA PRICE
DPM	To delete power monitoring, wattmeter panel and remote keying on any combiner	(\$331.15)

SECTION 1

M106-860 / M107-860 SERIES

COMPACT EXPANDABLE TRUNKING COMBINERS - 851-869 MHz 19" RACK MOUNT PANELS - 6" CAVITIES

M106 series combiner panels allow up to 5 channels to be installed on a 12.25" H x 19" W panel.

Each channel includes cavity, dual isolator, and loads (60 watt load on second stage load port).

Power monitoring and 19" racks available. Expandable to 10 channels with M106-860-1T/5T expansion kits.

MODEL	CH.	DESCRIPTION	FREQ. RANGE	PWR/ CHAN	GSA PRICE
M106-860-1TP	1	Compact Transmitter Combiner Panel	851-869 MHz	100 watts	\$1,228.66
M106-860-2TP	2	Compact Transmitter Combiner Panel	851-869 MHz	100 watts	\$2,027.14
M106-860-3TP	3	Compact Transmitter Combiner Panel	851-869 MHz	100 watts	\$2,825.61
M106-860-4TP	4	Compact Transmitter Combiner Panel	851-869 MHz	100 watts	\$3,624.88
M106-860-5TP	5	Compact Transmitter Combiner Panel	851-869 MHz	100 watts	\$4,423.35
M106-860-6TP	6	Compact Transmitter Combiner - 2 Panels	851-869 MHz	100 watts	\$5,787.91
M106-860-7TP	7	Compact Transmitter Combiner - 2 Panels	851-869 MHz	100 watts	\$6,586.38
M106-860-8TP	8	Compact Transmitter Combiner - 2 Panels	851-869 MHz	100 watts	\$7,384.85
M106-860-9TP	9	Compact Transmitter Combiner - 3 Panels	851-869 MHz	100 watts	\$8,184.13
M106-860-10TP	10	Compact Transmitter Combiner - 3 Panels	851-869 MHz	100 watts	\$8,982.60
M106-860-1T	1 channel expansion kit, 851-869 MHz. Specify frequency and channel number. No panel. Includes isolator, cavity, mounting hardware and cables.				\$798.47
M106-860-5T	5 channel expansion kit, 851-869 MHz. Expands 5 channel system to 10 ch. Includes tuning, panel, and cabling to connect existing panel as required.				\$4,559.25

EXPANDABLE LOW-LOSS COMBINERS - 851-869 MHz 19" RACK - 7" CAVITIES

Includes TBR72-19B rack, power monitoring, wattmeter panel, and remote keying.

Expandable to 10 Channels with M107-860-1T expansion kits.

MODEL	CH.	DESCRIPTION	FREQ. RANGE	PWR/ CHAN	GSA PRICE
M107-860-1TRM	1	Rack Mounted Transmitter Combiner	851-869 MHz	150 watts	\$3,170.53
M107-860-2TRM	2	Rack Mounted Transmitter Combiner	851-869 MHz	150 watts	\$4,485.36
M107-860-3TRM	3	Rack Mounted Transmitter Combiner	851-869 MHz	150 watts	\$5,801.00
M107-860-4TRM	4	Rack Mounted Transmitter Combiner	851-869 MHz	150 watts	\$7,115.84
M107-860-5TRM	5	Rack Mounted Transmitter Combiner	851-869 MHz	150 watts	\$8,430.66
M107-860-6TRM	6	Rack Mounted Transmitter Combiner	851-869 MHz	150 watts	\$9,745.49
M107-860-7TRM	7	Rack Mounted Transmitter Combiner	851-869 MHz	150 watts	\$11,061.16
M107-860-8TRM	8	Rack Mounted Transmitter Combiner	851-869 MHz	150 watts	\$12,375.98
M107-860-9TRM	9	Rack Mounted Transmitter Combiner	851-869 MHz	150 watts	\$13,691.64
M107-860-10TRM	10	Rack Mounted Transmitter Combiner	851-869 MHz	150 watts	\$15,006.45
M107-860-1T	1 channel expansion kit, 851-869 MHz. Must specify frequency and position.				\$1,404.30

SECTION 1

M107-860 SERIES

COMPACT HIGH POWER TRUNKING COMBINERS - 851-869 MHz 19" RACK - 7" CAVITIES

Each compact high power combiner includes TBR72-19B rack, power monitoring, wattmeter panel, -50 dB tuning sampler on 2nd isolator output stage 100 watt load, and remote keying. 17.5" panel.

MODEL	CH.	DESCRIPTION	FREQ. RANGE	PWR/ CHAN	GSA PRICE
M107860-1TRMHP	1	Rack Mounted High Power Combiner	851-869 MHz	175 watts	\$4,340.53
M107860-2TRMHP	2	Rack Mounted High Power Combiner	851-869 MHz	175 watts	\$6,141.72
M107860-3TRMHP	3	Rack Mounted High Power Combiner	851-869 MHz	175 watts	\$7,943.70
M107860-4TRMHP	4	Rack Mounted High Power Combiner	851-869 MHz	175 watts	\$9,745.69
M107860-5TRMHP	5	Rack Mounted High Power Combiner	851-869 MHz	175 watts	\$11,547.61
M107860-6TRMHP	6	Rack Mounted High Power Combiner	851-869 MHz	175 watts	\$13,348.79
M107860-7TRMHP	7	Rack Mounted High Power Combiner	851-869 MHz	175 watts	\$15,150.71
M107860-8TRMHP	8	Rack Mounted High Power Combiner	851-869 MHz	175 watts	\$16,952.62
M107860-9TRMHP	9	Rack Mounted High Power Combiner	851-869 MHz	175 watts	\$18,753.81
M107860-10TRMHP	10	Rack Mounted High Power Combiner	851-869 MHz	175 watts	\$20,555.72
M107860-1THP	1 channel expansion kit, 851-869 MHz. Must specify frequency and position.				\$1,922.53
M107860-5THP	5 channel expansion kit, 851-869 MHz. Expands 5 channel system to 10 ch.				\$8,440.64

OPTIONS

MODEL	DESCRIPTION	GSA PRICE
TWCH-393T	High Power 7-16 DIN Tee Harness. Includes 7-16 DIN Tee Connector, and (2) RG-393 7-16 DIN cables to interconnect two 5 channel combiners.	\$554.81
TWL-125CS	125 Watt Isolator 2nd stage load with temp. sensing TX cut-off (each channel)	\$181.37
DPM	To delete power monitoring, wattmeter panel and remote keying on any combiner	(\$331.15)

SECTION 1

M101-860 / M101-900 SERIES

EXPANDABLE TRUNKING LOW-LOSS COMBINERS - 806-869 MHz

19" RACK - 8" CAVITIES

8" cavities for close spacing. Available in 5 or 10 channel racks. Expandable with M101-860-1T/5T expansion kits. Includes TBR72-19B rack, power monitoring, wattmeter panel, and remote keying. Combining solutions are available to integrate 763-869 MHz channels into a single rack. Contact Telewave for more information.

MODEL	CH.	DESCRIPTION	FREQ. RANGE	PWR/ CHAN	GSA PRICE
M101-860-1TRM	1	Rack Mounted Transmitter Combiner	806-869 MHz	150 watts	\$3,261.43
M101-860-2TRM	2	Rack Mounted Transmitter Combiner	806-869 MHz	150 watts	\$4,613.93
M101-860-3TRM	3	Rack Mounted Transmitter Combiner	806-869 MHz	150 watts	\$5,967.23
M101-860-4TRM	4	Rack Mounted Transmitter Combiner	806-869 MHz	150 watts	\$7,320.53
M101-860-5TRM	5	Rack Mounted Transmitter Combiner	806-869 MHz	150 watts	\$8,673.02
M101-860-6TRM	6	Rack Mounted Transmitter Combiner	806-869 MHz	150 watts	\$10,025.52
M101-860-7TRM	7	Rack Mounted Transmitter Combiner	806-869 MHz	150 watts	\$11,378.82
M101-860-8TRM	8	Rack Mounted Transmitter Combiner	806-869 MHz	150 watts	\$12,731.32
M101-860-9TRM	9	Rack Mounted Transmitter Combiner	806-869 MHz	150 watts	\$14,084.62
M101-860-10TRM	10	Rack Mounted Transmitter Combiner	806-869 MHz	150 watts	\$15,437.11

EXPANSION KITS

MODEL	DESCRIPTION	GSA PRICE
M101-860-1T	1 channel expansion kit, 806-869 MHz. Specify frequency and position. Includes cavity, isolator, power monitor, mounting hardware and cables.	\$1,444.97
M101-860-5T	5 channel expansion kit, 806-869 MHz. Adds 5 channels to existing system. Includes panel, and expansion harness to connect existing panel.	\$6,341.94

OPTIONS

MODEL	DESCRIPTION	GSA PRICE
DPM	To delete power monitoring, wattmeter panel and remote keying on any combiner	(\$331.15)

EXPANDABLE TRUNKING HYBRID COMBINERS - 896-941 MHz

19" RACK - HYBRID TRAYS

Includes TBR72-19B rack, power monitoring, wattmeter panel and remote keying.

MODEL	CH.	DESCRIPTION	FREQ. RANGE	PWR/ CHAN	GSA PRICE
M101-900-2TRMH	2	Rack Mounted Hybrid Transmitter Combiner	896-941 MHz	150 watts	\$3,062.18
M101-900-4TRMH	4	Rack Mounted Hybrid Transmitter Combiner	896-941 MHz	150 watts	\$5,892.11
M101-900-10TRMH	10	Rack Mounted Hybrid Transmitter Combiner	896-941 MHz	150 watts	\$14,255.49
M101-900-2TH		2 channel expansion kit, 896-941 MHz. For 2 channel or 4 channel combiner. Includes hybrid coupler, cables, and all mounting hardware.			\$2,584.51
M101-900-4TH		4 channel expansion kit, 896-941 MHz. For 2 channel or 4 channel combiner. Includes hybrid coupler, cables, and all mounting hardware.			\$5,414.43

SECTION 1

CERAMIC SERIES

CERAMIC ENHANCED TRUNKING COMBINERS - 851-869 MHz

19" RACK - 4" CAVITIES

Requires only 7.5" of rack space for 5 channels. Expandable to 10 channels with TC860-1T/5T expansion kits. Includes TBR72-19B rack, power monitoring, wattmeter panel and remote keying.

MODEL	CH.	DESCRIPTION	FREQ. RANGE	PWR/ CHAN	GSA PRICE
TC860-1TRM	1	Rack Mounted Ceramic Enhanced Combiner	851-869 MHz	80 watts	\$3,369.98
TC860-2TRM	2	Rack Mounted Ceramic Enhanced Combiner	851-869 MHz	80 watts	\$4,829.42
TC860-3TRM	3	Rack Mounted Ceramic Enhanced Combiner	851-869 MHz	80 watts	\$6,288.87
TC860-4TRM	4	Rack Mounted Ceramic Enhanced Combiner	851-869 MHz	80 watts	\$7,748.31
TC860-5TRM	5	Rack Mounted Ceramic Enhanced Combiner	851-869 MHz	80 watts	\$9,207.75
TC860-6TRM	6	Rack Mounted Ceramic Enhanced Combiner	851-869 MHz	80 watts	\$10,667.99
TC860-7TRM	7	Rack Mounted Ceramic Enhanced Combiner	851-869 MHz	80 watts	\$12,127.44
TC860-8TRM	8	Rack Mounted Ceramic Enhanced Combiner	851-869 MHz	80 watts	\$13,587.68
TC860-9TRM	9	Rack Mounted Ceramic Enhanced Combiner	851-869 MHz	80 watts	\$15,047.12
TC860-10TRM	10	Rack Mounted Ceramic Enhanced Combiner	851-869 MHz	80 watts	\$16,507.37
TC860-1T	1 channel expansion kit, 851-869 MHz. Must specify frequency and position.				\$1,551.11
TC860-5T	5 channel expansion kit, 851-869 MHz. Expands 5 channel system to 10 ch.				\$6,877.47

CERAMIC ENHANCED CELLULAR COMBINERS - 869-896 MHz

19" RACK - 4" CAVITIES

Requires only 8.75" of rack space for up to 8 channels. Each channel is rated at 80 watts, and includes one T8630 isolator and power monitoring.

MODEL	CH.	DESCRIPTION	FREQ. RANGE	PWR/ CHAN	GSA PRICE
TC804-4	4	Rack Mounted Ceramic Enhanced Combiner	869-896 MHz	80 watts	\$4,674.23
TC804-8	8	Rack Mounted Ceramic Enhanced Combiner	869-896 MHz	80 watts	\$9,087.25
TC804-12	12	Rack Mounted Ceramic Enhanced Combiner	869-896 MHz	80 watts	\$14,022.70
TC804-16	16	Rack Mounted Ceramic Enhanced Combiner	869-896 MHz	80 watts	\$18,696.93
TC804-24	24	Rack Mounted Ceramic Enhanced Combiner	869-896 MHz	80 watts	\$28,045.40
TC804-36	36	Rack Mounted Ceramic Enhanced Combiner	869-896 MHz	80 watts	\$37,394.67
TC804-4X	Expands 4, 8, 12, 20 and 24 channel systems by an additional 4 channels				\$4,711.22
TC804-8X	Expands 8, 16 and 24 channel systems by an additional 8 channels				\$9,436.92

CERAMIC ENHANCED GSM COMBINERS - 935-960 MHz

19" RACK - 4" CAVITIES

Requires only 8.75" of rack space for up to 4 channels. Two cavities per channel provide 200 KHz bandwidth. Each channel is rated at 80 watts, and includes one T8630 isolator and power monitoring.

MODEL	CH.	DESCRIPTION	FREQ. RANGE	PWR/ CHAN	GSA PRICE
TC9042-4	4	Rack Mounted Ceramic Enhanced Combiner	935-960 MHz	80 watts	\$6,505.17
TC9042-8	8	Rack Mounted Ceramic Enhanced Combiner	935-960 MHz	80 watts	\$13,418.02
TC9042-12	12	Rack Mounted Ceramic Enhanced Combiner	935-960 MHz	80 watts	\$20,275.38
TC9042-16	16	Rack Mounted Ceramic Enhanced Combiner	935-960 MHz	80 watts	\$26,784.57
TC9042-4X	Expansion Kit. Adds 4 channels to existing system.				\$6,810.73
TC9042-8X	Expansion Kit. Adds 8 channels to existing system.				\$13,725.18

SECTION 1

AUTOTUNE SERIES

AUTOTUNING CERAMIC ENHANCED LOW-LOSS COMBINERS - 851-869 MHz

Each channel includes an isolator, microprocessor-based controller, and forward/reverse channel power, fault and parameter monitoring via RS-485/-232 data link.

Each combiner assembly includes full RF harness, +24/-48 VDC power supply, and mounts on a 7" x 19" panel.

MODEL	CH.	DESCRIPTION	FREQ. RANGE	PWR/ CHAN	GSA PRICE
TATC-8644-3R	4	Autotuning Ceramic Enhanced Combiner	851-869 MHz	100 watts	\$8,233.98
TATC-8645-3R	5	Autotuning Ceramic Enhanced Combiner	851-869 MHz	100 watts	\$9,810.02
TATC-8646-3R	6	Autotuning Ceramic Enhanced Combiner	851-869 MHz	100 watts	\$11,386.79
TATC-8648-3R	8	Autotuning Ceramic Enhanced Combiner	851-869 MHz	100 watts	\$15,183.60

OPTIONS

MODEL	DESCRIPTION	GSA PRICE
TATC-8645-OPTA	PMU2C1S Wattmeter. Displays channel and antenna forward / reverse power. Alarms for low power and high VSWR. RS-232 to RS-485 converter built in.	\$2,202.50
TATC-8645-OPTB	TW2-860-7-16 2-way combiner Tee with 7-16 DIN connector on antenna output.	\$132.13
TATC-8645-OPTC	External Modem and Computer Cable	\$171.53
TATC-8645-OPTD	Isolated RS-232 to RS-485 converter for computer monitoring and control. Used when PMU is not installed on front panel. Includes cables.	\$259.35
TATC-8645-OPTE	Accessory Cable - Connects RS-485 converter to RS-232 device	\$48.42
TATC-8645-OPTF	RG-393 critical-length N-Male cable set for combining two 5 channel panels.	\$39.39
TATC-8645-OPTG	7-16 male connector for RG-393 coax cable	\$48.42
TATC-8645-OPTH	Tee connector - N-F / 7-16 DIN-F / N-F	\$155.11
TATC-8645-OPTJ	TBR72-19B - Steel rack, 72" H x 19" W	\$320.90

SECTION 1

PASS / NOTCH SERIES

BANDPASS-NOTCH COMBINERS - 66-512 MHz

Each combiner is a self-contained unit for one transmitter. Up to 3 pass cavities are available for maximum isolation. Each unit is assembled with 19" rails for rack or wall mounting.

MODEL	CH.	DESCRIPTION	FREQ. RANGE	PWR/ CHAN	GSA PRICE
M101-70-1T-1PN	1	Transmitter Combiner - 1 Pass, 1 Notch	66-88 MHz	150 watts	\$764.10
M101-70-1T-2PN	1	Transmitter Combiner - 2 Pass, 1 Notch	66-88 MHz	150 watts	\$1,040.70
M101-70-1T-3PN	1	Transmitter Combiner - 3 Pass, 1 Notch	66-88 MHz	150 watts	\$1,296.76
M101-150-1T-1PN	1	Transmitter Combiner - 1 Pass, 1 Notch	136-174 MHz	150 watts	\$597.49
M101-150-1T-2PN	1	Transmitter Combiner - 2 Pass, 1 Notch	136-174 MHz	150 watts	\$888.85
M101-150-1T-3PN	1	Transmitter Combiner - 3 Pass, 1 Notch	136-174 MHz	150 watts	\$1,107.99
M101-450-1T-1PN	1	Transmitter Combiner - 1 Pass, 1 Notch	400-512 MHz	150 watts	\$514.60
M101-450-1T-2PN	1	Transmitter Combiner - 2 Pass, 1 Notch	400-512 MHz	150 watts	\$764.92
M101-450-1T-3PN	1	Transmitter Combiner - 3 Pass, 1 Notch	400-512 MHz	150 watts	\$1,089.12

OPTIONS

MODEL	DESCRIPTION	FREQ. RANGE	GSA PRICE
T-1030CM	Single isolator, cavity mount. Includes 35 watt removable load.	66-88 MHz	\$432.53
T-1060CM	Dual isolator, cavity mount. Includes two 35 watt removable loads.	66-88 MHz	\$779.70
T-1530CM	Single isolator, cavity mount. Includes 35 watt removable load.	136-174 MHz	\$432.53
T-1560CM	Dual isolator, cavity mount. Includes two 35 watt removable loads.	136-174 MHz	\$779.70
T-4530CM	Single isolator, cavity mount. Includes 35 watt removable load.	400-512 MHz	\$432.53
T-4560CM	Dual isolator, cavity mount. Includes two 35 watt removable loads.	400-512 MHz	\$779.70
CBL214T	RG-214T Mil. Spec. combiner interconnection cable, per foot		\$1.90
UG-21	Adapter - N Female to UHF Male		\$4.27

SECTION 1

HYBRID SERIES

HYBRID TRANSMITTER COMBINERS AND COUPLERS - 118-960 MHz

Combiners and Couplers can be mounted on standard EIA 19" panel, and include isolators and loads.

TW-860 compact combiners require only 3.5" of rack space for two **or** four channels at 125 watts.

Standard two channel models are 5.25" high. Four channel models are 10.5" high. 400 watt models available.

MODEL	CH.	DESCRIPTION	FREQ. RANGE	ISOL.	PWR/ CH.	GSA PRICE
TW150-2HRA1	2	Hybrid Transmitter Combiner	118-174 MHz	70 dB	150 W	\$1,771.43
TW150-2HRB1	2	Hybrid Transmitter Combiner	118-174 MHz	100 dB	150 W	\$2,494.32
TW150-4HRA1	4	Hybrid Transmitter Combiner	118-174 MHz	70 dB	150 W	\$4,042.21
TW150-4HRB1	4	Hybrid Transmitter Combiner	118-174 MHz	100 dB	150 W	\$5,484.77
TW150-2HRA2	2	High Power Hybrid Combiner	148-174 MHz	70 dB	300 W	\$3,793.74
TW150-2HRB2	2	High Power Hybrid Combiner	148-174 MHz	100 dB	300 W	\$4,961.30
TW150-4HRA2	4	High Power Hybrid Combiner	148-174 MHz	70 dB	300 W	\$6,230.17
TW150-4HRB2	4	High Power Hybrid Combiner	148-174 MHz	100 dB	300 W	\$7,661.46
TW220-2HRA1	2	Hybrid Transmitter Combiner	216-250 MHz	70 dB	150 W	\$1,771.43
TW220-2HRB1	2	Hybrid Transmitter Combiner	216-250 MHz	100 dB	150 W	\$2,494.32
TW220-4HRA1	4	Hybrid Transmitter Combiner	216-250 MHz	70 dB	150 W	\$4,042.21
TW220-4HRB1	4	Hybrid Transmitter Combiner	216-250 MHz	100 dB	150 W	\$5,484.77
TW450-2HRA1	2	Hybrid Transmitter Combiner	406-512 MHz	70 dB	150 W	\$1,690.22
TW450-2HRB1	2	Hybrid Transmitter Combiner	406-512 MHz	100 dB	150 W	\$2,379.33
TW450-4HRA1	4	Hybrid Transmitter Combiner	406-512 MHz	70 dB	150 W	\$3,859.68
TW450-4HRB1	4	Hybrid Transmitter Combiner	406-512 MHz	100 dB	150 W	\$5,236.30
TW760-2HRA1	2	Hybrid Transmitter Combiner	763-869 MHz	70 dB	150 W	\$2,198.12
TW760-2HRB1	2	Hybrid Transmitter Combiner	763-869 MHz	100 dB	150 W	\$2,626.48
TW760-4HRA1	4	Hybrid Transmitter Combiner	763-869 MHz	70 dB	150 W	\$4,445.21
TW760-4HRB1	4	Hybrid Transmitter Combiner	763-869 MHz	100 dB	150 W	\$6,032.21
TW860-2HRB1	2	Compact Hybrid Transmitter Combiner	851-960 MHz	90 dB	100 W	\$1,554.33
TW860-2HRB1H	2	Compact High Power Hybrid Combiner	851-960 MHz	90 dB	150 W	\$2,033.57
TW860-4HRB1	4	Compact Hybrid Transmitter Combiner	851-960 MHz	90 dB	100 W	\$3,285.55
TW860-4HRB1H	4	Compact High Power Hybrid Combiner	851-960 MHz	90 dB	150 W	\$4,679.86
TW900-2HRA1	2	Hybrid Transmitter Combiner	806-960 MHz	70 dB	150 W	\$1,816.46
TW900-2HRB1	2	Hybrid Transmitter Combiner	806-960 MHz	100 dB	150 W	\$2,170.27
TW900-4HRA1	4	Hybrid Transmitter Combiner	806-960 MHz	70 dB	150 W	\$3,673.13
TW900-4HRB1	4	Hybrid Transmitter Combiner	806-960 MHz	100 dB	150 W	\$4,985.42
TW930-2HRA1-SL	2	STL Hybrid Combiner	900-960 MHz	70 dB	25 W	\$1,284.15
TWH-150		Hybrid Coupler	144-174 MHz		400 W	\$314.40
TWH-450		Hybrid Coupler	406-512 MHz		400 W	\$314.40
TWH-900		Hybrid Coupler	806-960 MHz		400 W	\$340.94

SECTION 1**RACKS / CABINETS****COMBINER RACKS AND CABINETS**

MODEL	DESCRIPTION	GSA PRICE
TBR72-19B	Steel Bud Relay Rack with cross-bracing. 72" H x 19" W	\$322.44
TBR84-19B	Steel Bud Relay Rack with cross-bracing. 84" H x 19" W	\$340.94
TBR90-19C	Bolted Chatsworth aluminum relay rack. 90" H x 19" W	\$812.87
TBC-40	Upright floor mount indoor cabinet with removable front panel. 40" H x 22" W x 17" D	\$602.42
TBC-48	Deluxe 48" upright floor mount indoor cabinet with front and rear locking doors. Standard color black. Call for color and seismic bracing options 48" H x 24" W x 32" D (150 MHz) 48" H x 24" W x 24" D (350/450 MHz)	\$681.88
TBC-70	Deluxe 70" upright floor mount indoor cabinet with front and rear locking doors. Standard color black. Call for color and seismic bracing options 70" H x 22" W x 25.5" D	\$1,528.59
TWX-5	Standoff brackets for rack-mounted equipment (2 ea) - 5.25 x 5.25"	\$36.18
TWX-8	Standoff brackets for rack-mounted equipment (2 ea) - 8 x 8"	\$43.13

RECEIVER DISTRIBUTION PANEL MODEL NUMBER NOMENCLATURE

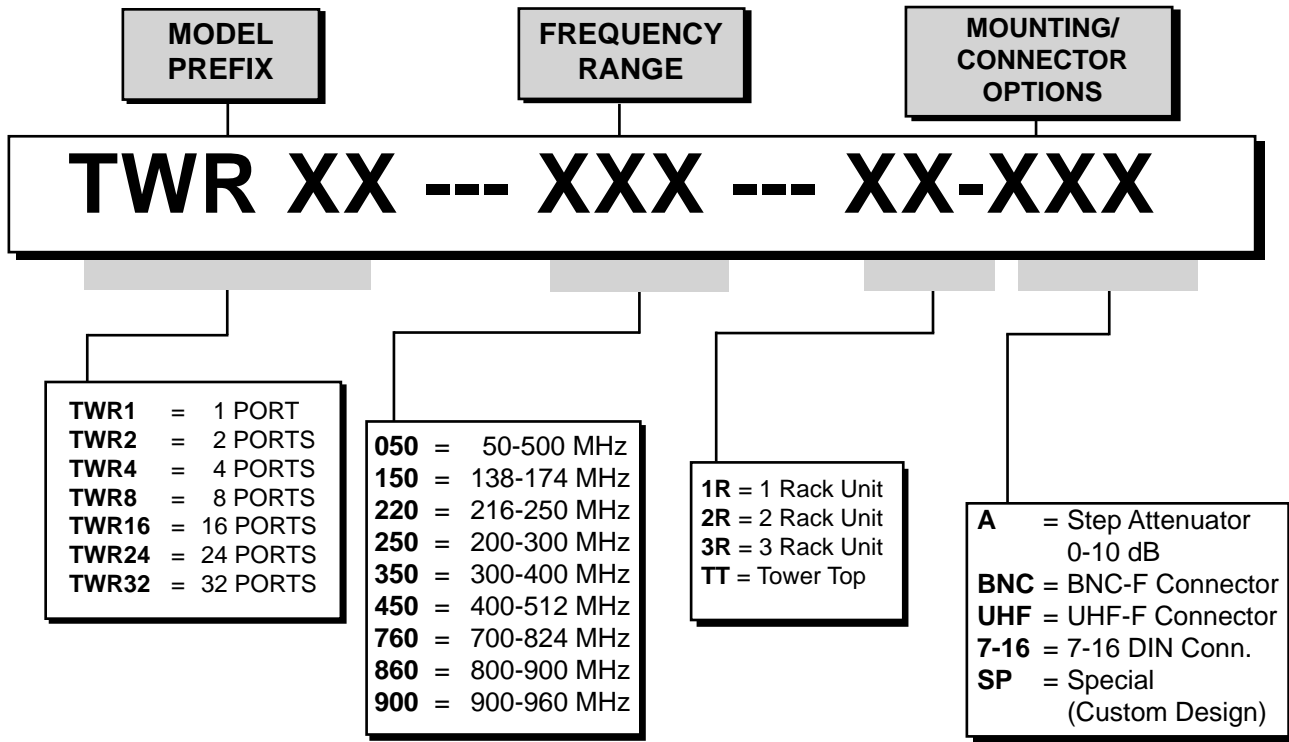

EXAMPLE:

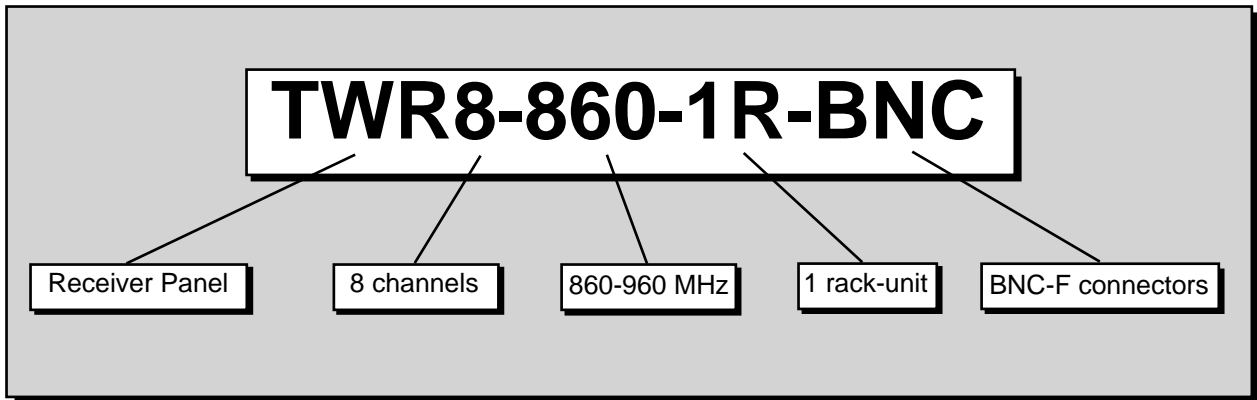

NOTES:

Receiver Distribution Panels Ship Standard With N-Female Connectors

Standard Power Supply Voltages Available:

+12 VDC +15 VDC +24 VDC +48VDC 120 VAC 220 VAC

SECTION 2

RECEIVER DISTRIBUTION PANELS

2 / 4 CHANNEL RECEIVER DISTRIBUTION PANELS

All receiver distribution panels are 19" W x 5.25" H x 4" D, and are normally supplied with N-Female connectors. Includes AC power supply for 100-240 VAC 50/60 Hz. DC power input +12 to +24 VDC. Typical system gain 6 dB.

MODEL	DESCRIPTION	FREQ. RANGE	SYSTEM GAIN*	GSA PRICE
TWR2-150	2 Channel Receiver Distribution Panel	132-174 MHz	0-18 dB	\$884.51
TWR2-250	2 Channel Receiver Distribution Panel	216-250 MHz	0-18 dB	\$884.51
TWR2-350	2 Channel Receiver Distribution Panel	300-400 MHz	0-18 dB	\$884.51
TWR2-450	2 Channel Receiver Distribution Panel	400-512 MHz	0-18 dB	\$884.51
TWR2-760	2 Channel Receiver Distribution Panel	763-824 MHz	0-18 dB	\$884.51
TWR2-860	2 Channel Receiver Distribution Panel	806-960 Mhz	0-18 dB	\$884.51
TWR4-150	4 Channel Receiver Distribution Panel	132-174 MHz	0-18 dB	\$946.65
TWR4-250	4 Channel Receiver Distribution Panel	216-250 MHz	0-18 dB	\$946.65
TWR4-350	4 Channel Receiver Distribution Panel	300-400 MHz	0-18 dB	\$946.65
TWR4-450	4 Channel Receiver Distribution Panel	400-512 MHz	0-18 dB	\$946.65
TWR4-760	4 Channel Receiver Distribution Panel	763-824 MHz	0-18 dB	\$946.65
TWR4-860	4 Channel Receiver Distribution Panel	806-960 Mhz	0-18 dB	\$946.65

NOTE: Unused ports must be terminated with 50 ohm load such as TWL-01.

* Factory Adjustable

8 / 16 / 24 CHANNEL RECEIVER DISTRIBUTION PANELS

All receiver distribution panels are 19" W x 7" H x 3" D, and are normally supplied with N-Female connectors, -20 dB test port, and 120 or 220 VAC 60 Hz / + 12 VDC power supply. Typical system gain 6 dB.

MODEL	DESCRIPTION	FREQ. RANGE	SYSTEM GAIN*	GSA PRICE
TWR8-050	8 Channel Receiver Distribution Panel	50-512 MHz	0-18 dB	\$1,032.50
TWR8-150	8 Channel Receiver Distribution Panel	132-174 MHz	0-18 dB	\$1,009.15
TWR8-250	8 Channel Receiver Distribution Panel	216-250 MHz	0-18 dB	\$1,009.15
TWR8-350	8 Channel Receiver Distribution Panel	300-400 MHz	0-18 dB	\$1,009.15
TWR8-450	8 Channel Receiver Distribution Panel	400-512 MHz	0-18 dB	\$1,009.15
TWR8-760	8 Channel Receiver Distribution Panel	763-824 MHz	0-18 dB	\$1,009.15
TWR8-860	8 Channel Receiver Distribution Panel	806-960 Mhz	0-18 dB	\$1,009.15
TWR16-050	16 Channel Receiver Distribution Panel	50-512 MHz	0-15 dB	\$1,674.31
TWR16-150	16 Channel Receiver Distribution Panel	132-174 MHz	0-15 dB	\$1,518.14
TWR16-250	16 Channel Receiver Distribution Panel	216-250 MHz	0-15 dB	\$1,518.14
TWR16-350	16 Channel Receiver Distribution Panel	300-400 MHz	0-15 dB	\$1,518.14
TWR16-450	16 Channel Receiver Distribution Panel	400-512 MHz	0-15 dB	\$1,518.14
TWR16-760	16 Channel Receiver Distribution Panel	763-824 MHz	0-15 dB	\$1,518.14
TWR16-860	16 Channel Receiver Distribution Panel	806-960 MHz	0-15 dB	\$1,617.05
TWR24-760	24 Channel Receiver Distribution Panel	763-824 MHz	0-12 dB	\$2,176.70
TWR24-860	24 Channel Receiver Distribution Panel	806-960 MHz	0-12 dB	\$1,798.77

NOTE: Unused ports must be terminated with 50 ohm load such as TWL-01.

* Factory Adjustable

SECTION 2

RECEIVER DISTRIBUTION PANELS

COMPACT RECEIVER DISTRIBUTION PANELS 8-16 CHANNELS

All panels are 1RU (1.75") for 19" rack mount. Typical system gain 6 dB. Standard connectors are N-Female. BNC opt. 0-10 dB step attenuator optional on all panels. 8-way panels can be expanded to 16 channels. Includes power supply for 120 or 220 VAC / +11.5 to +15 VDC input.

MODEL	DESCRIPTION	FREQ. RANGE	SYSTEM GAIN*	GSA PRICE
TWR8-050-1R	8 Channel Compact Distribution Panel, 1RU	50-512 MHz	0-18 dB	\$1,594.69
TWR8-050-1RA	TWR8-050-1R with 10dB Step Attenuator	50-512 MHz	0-18 dB	\$2,327.87
TWR8-050-1RTT*	8 Channel Compact Distribution Panel, 1RU	50-512 MHz	0-18 dB	\$1,920.53
TWR8-150-1R	8 Channel Compact Distribution Panel, 1RU	132-174 MHz	0-18 dB	\$1,804.11
TWR8-150-1RA	TWR8-150-1R with 10dB Step Attenuator	132-174 MHz	0-18 dB	\$2,327.87
TWR8-150-1RTT*	8 Channel Compact Distribution Panel, 1RU	132-174 MHz	0-18 dB	\$2,173.26
TWR8-450-1R	8 Channel Compact Distribution Panel, 1RU	400-512 MHz	0-18 dB	\$1,345.26
TWR8-450-1RA	TWR8-450-1R with 10dB Step Attenuator	400-512 MHz	0-18 dB	\$1,971.51
TWR8-450-1RTT*	8 Channel Compact Distribution Panel, 1RU	400-512 MHz	0-18 dB	\$1,678.96
TWR8-760-1R	8 Channel Compact Distribution Panel, 1RU	763-824 MHz	0-18 dB	\$1,479.54
TWR8-760-1RA	TWR8-760-1R with 10dB Step Attenuator	763-824 MHz	0-18 dB	\$1,971.51
TWR8-760-1RTT*	8 Channel Compact Distribution Panel, 1RU	763-824 MHz	0-18 dB	\$1,847.02
TWR8-760-1R-BNC**	8 Channel Compact Distribution Panel, 1RU	763-824 MHz	0-18 dB	\$1,479.54
TWR8-860-1R	8 Channel Compact Distribution Panel, 1RU	806-960 MHz	0-18 dB	\$1,345.26
TWR8-860-1RA	TWR8-860-1R with 10dB Step Attenuator	806-960 MHz	0-18 dB	\$1,971.51
TWR8-860-1RTT*	8 Channel Compact Distribution Panel, 1RU	806-960 MHz	0-18 dB	\$1,678.96
TWR8-860-1R-BNC**	8 Channel Compact Distribution Panel, 1RU	806-960 MHz	0-18 dB	\$1,345.26
TWR16-050-1R	16 Channel Compact Distribution Panel, 1RU	50-512 MHz	0-15 dB	\$2,463.04
TWR16-050-1RTT*	16 Channel Compact Distribution Panel, 1RU	50-512 MHz	0-15 dB	\$2,788.06
TWR16-150-1R	16 Channel Compact Distribution Panel, 1RU	132-174 MHz	0-15 dB	\$2,787.01
TWR16-150-1RTT*	16 Channel Compact Distribution Panel, 1RU	132-174 MHz	0-15 dB	\$3,155.00
TWR16-450-1R	16 Channel Compact Distribution Panel, 1RU	400-512 MHz	0-15 dB	\$1,940.29
TWR16-450-1RTT*	16 Channel Compact Distribution Panel, 1RU	400-512 MHz	0-15 dB	\$2,275.60
TWR16-760-1R	16 Channel Compact Distribution Panel, 1RU	763-824 MHz	0-15 dB	\$2,133.79
TWR16-760-1RTT*	16 Channel Compact Distribution Panel, 1RU	763-824 MHz	0-15 dB	\$2,502.94
TWR16-760-1RBNC**	16 Channel Compact Distribution Panel, 1RU	763-824 MHz	0-15 dB	\$2,133.79
TWR16-860-1R	16 Channel Compact Distribution Panel, 1RU	806-960 MHz	0-15 dB	\$1,940.29
TWR16-860-1RTT*	16 Channel Compact Distribution Panel, 1RU	806-960 MHz	0-15 dB	\$2,275.60
TWR16-860-1RBNC**	16 Channel Compact Distribution Panel, 1RU	806-960 MHz	0-15 dB	\$2,133.79

NOTES:

Unused ports must be terminated with 50 ohm load such as TWL-01.

* Includes 1 Amp meter movement & DC power injector for Tower Top Preamp.

** Output connectors are BNC.

* Factory Adjustable

SECTION 2

RECEIVER DISTRIBUTION PANELS

COMPACT RECEIVER PANELS 24-32 CHANNELS

All panels are 2RU (3.5") for 19" rack mount. Typical system gain 6 dB. Standard connectors are N-Female. BNC-F opt. 0-10 dB step attenuator optional on all panels. 24-way panels can be expanded to 32 channels. Includes power supply for 120 or 220 VAC / +11.5 to +15 VDC input.

MODEL	DESCRIPTION	FREQ. RANGE	SYSTEM GAIN*	GSA PRICE
TWR24-050-2R	24 Channel Compact Distribution Panel, 2RU	50-512 MHz	0-12 dB	\$3,234.68
TWR24-150-2R	24 Channel Compact Distribution Panel, 2RU	132-174 MHz	0-12 dB	\$3,234.68
TWR24-450-2R	24 Channel Compact Distribution Panel, 2RU	400-512 MHz	0-12 dB	\$2,581.89
TWR24-760-2R	24 Channel Compact Distribution Panel, 2RU	763-824 MHz	0-12 dB	\$2,581.89
TWR24-860-2R	24 Channel Compact Distribution Panel, 2RU	806-960 MHz	0-12 dB	\$2,581.89
TWR32-050-2R	32 Channel Compact Distribution Panel, 2RU	50-512 MHz	0-12 dB	\$3,534.02
TWR32-150-2R	32 Channel Compact Distribution Panel, 2RU	132-174 MHz	0-12 dB	\$3,534.02
TWR32-450-2R	32 Channel Compact Distribution Panel, 2RU	400-512 MHz	0-12 dB	\$2,880.87
TWR32-760-2R	32 Channel Compact Distribution Panel, 2RU	763-824 MHz	0-12 dB	\$2,880.87
TWR32-860-2R	32 Channel Compact Distribution Panel, 2RU	806-960 MHz	0-12 dB	\$2,880.87

NOTE: Unused ports of compact panels must be terminated with 50 ohm load such as TWL-01. * Factory Adjustable

RECEIVER POWER SPLITTERS

Receiver splitters are designed for *receiver* systems only. Splitters are factory tuned for best performance in 150-174, 450-470, 793-824, and 806-824 MHz bands. Please specify center frequency if outside these ranges.

MODEL	DESCRIPTION	FREQ. RANGE	TYP. LOSS	GSA PRICE
PS-302	2-Port Receiver Power Splitter	33-50 MHz	-3.2 dB	\$63.52
PS-702	2-Port Receiver Power Splitter	72-88 MHz	-3.2 dB	\$63.52
PS-1502	2-Port Receiver Power Splitter	132-174 MHz	-3.2 dB	\$61.55
PS-1504	4-Port Receiver Power Splitter	132-174 MHz	-6.4 dB	\$123.03
PS-3302	2-Port Receiver Power Splitter	320-390 MHz	-3.2 dB	\$63.52
PS-4502	2-Port Receiver Power Splitter	400-512 MHz	-3.2 dB	\$63.52
PS-4504	4-Port Receiver Power Splitter	400-512 MHz	-6.4 dB	\$123.03
PS-4508-BNC	8-Port Receiver Power Splitter BNC-F	400-512 MHz	-9.6 dB	\$274.13
PS-4508-N	8-Port Receiver Power Splitter N-F	400-512 MHz	-9.6 dB	\$298.98
PS-7602	2-Port Receiver Power Splitter.	763-824 MHz	-3.2 dB	\$80.41
PS-7604	4-Port Receiver Power Splitter.	763-824 MHz	-6.4 dB	\$148.76
PS-7608-BNC	8-Port Receiver Power Splitter BNC-F	763-824 MHz	-9.6 dB	\$274.13
PS-7608-N	8-Port Receiver Power Splitter N-F	763-824 MHz	-9.6 dB	\$298.98
PS-8602	2-Port Receiver Power Splitter	806-960 MHz	-3.2 dB	\$63.52
PS-8604	4-Port Receiver Power Splitter	806-960 MHz	-6.4 dB	\$123.03
PS-8608-BNC	8-Port Receiver Power Splitter BNC-F	806-960 MHz	-9.6 dB	\$274.13
PS-8608-N	8-Port Receiver Power Splitter N-F	806-960 MHz	-9.6 dB	\$298.98
PS-5002 *	Broadband 2-Port Receiver Power Splitter	10-1000 MHz	-3.2 dB	\$147.95
PS-5004 *	Broadband 4-Port Receiver Power Splitter	10-1000 MHz	-6.4 dB	\$274.20

NOTE: Unused splitter ports must be terminated with 50 ohm load such as TWL-01.

SECTION 2

RECEIVER PREAMPLIFIERS

RACK MOUNT PHEMT PREAMPLIFIERS

Preamplifiers are mounted on a 1.75" H x 19" W (1RU) panel, and include a 0-10dB attenuator and 120 or 220 VAC to +11-18 VDC power supply. Bandwidth is approximately 10% of operating frequency for each unit. Specify operating or center frequency with order. N-Female input/output connectors standard.

MODEL	DESCRIPTION	FREQ. RANGE	SYSTEM GAIN*	GSA PRICE
TWR1-150	Rack Mount PHEMT Preamp with 10dB attenuator	132-174 MHz	+1 to +11 dB +8 to +18 dB	\$1,265.65
TWR1-220	Rack Mount PHEMT Preamp with 10dB attenuator	200-250 MHz	+1 to +11 dB +8 to +18 dB	\$1,265.65
TWR1-450	Rack Mount PHEMT Preamp with 10dB attenuator	400-512 MHz	+1 to +11 dB +7 to +17 dB	\$1,265.65
TWR1-760	Rack Mount PHEMT Preamp with 10dB attenuator	763-824 MHz	+1 to +11 dB +4 to +14 dB	\$1,391.82
TWR1-860	Rack Mount PHEMT Preamp with 10dB attenuator	800-960 MHz	+1 to +11 dB +4 to +14 dB	\$1,265.65

* Gain window is factory adjustable between limits shown.

PREAMP / RELAY PANEL

Preamp and relay are mounted on a 3" H x 19" W (2RU) panel. N-Female input/output connectors standard.

MODEL	DESCRIPTION	FREQ. RANGE	GAIN*	GSA PRICE
TWR1-300-1RDPA	Preamp / Relay Panel, +24 VDC. Includes Bipolar preamp, rotary attenuator, and 100 watt DPDT relay.	30-88 MHz	+1 to +11 dB +20 to +30 dB	\$2,060.51

* Gain window is factory adjustable between limits shown.

BIPOLAR PREAMPLIFIERS

Specify operating or center frequency with order. N-Female input/output connectors standard.

MODEL	DESCRIPTION	FREQ. RANGE	GAIN*	GSA PRICE
TLA50-12	Bipolar inline preamplifier, +12 to +24VDC (specify freq.)	30-88 MHz	8-34 dB	\$388.16
TLA150-12	Bipolar inline preamplifier, +12 to +24VDC (specify freq.)	132-174 MHz	6-28 dB	\$353.00
TLA220-12	Bipolar inline preamplifier, +12 to +24VDC (specify freq.)	216-250 MHz	6-28 dB	\$353.00
TLA330-12	Bipolar inline preamplifier, +12 to +24VDC (specify freq.)	320-390 MHz	6-28 dB	\$353.00
TLA450-12	Bipolar inline preamplifier, +12 to +24VDC (specify freq.)	400-512 MHz	6-30 dB	\$353.00
TLA760-12	Bipolar inline preamplifier, +12 to +24VDC (specify freq.)	763-824 MHz	6-21 dB	\$388.16
TLA860-12	Bipolar inline preamplifier, +12 to +24VDC (specify freq.)	806-960 MHz	6-21 dB	\$353.00

* Factory Adjustable

PHEMT PREAMPLIFIERS

Specify operating or center frequency with order. N-Female input/output connectors standard.

MODEL	DESCRIPTION	FREQ. RANGE	GAIN*	GSA PRICE
TGA150-12	PHEMT inline preamplifier, +9 to +18VDC (specify freq.)	132-174 MHz	20 dB	\$425.37
TGA220-12	PHEMT inline preamplifier, +9 to +18VDC (specify freq.)	200-250 MHz	17 dB	\$467.84
TGA450-12	PHEMT inline preamplifier, +9 to +18VDC (specify freq.)	400-512 MHz	17 dB	\$425.37
TGA750-12	PHEMT inline preamplifier, +9 to +18VDC (specify freq.)	763-824 MHz	14 dB	\$467.84
TGA860-12	PHEMT inline preamplifier, +9 to +18VDC (specify freq.)	806-960 MHz	14 dB	\$425.37

* Factory Adjustable

PRESELECTOR MODEL NUMBER NOMENCLATURE

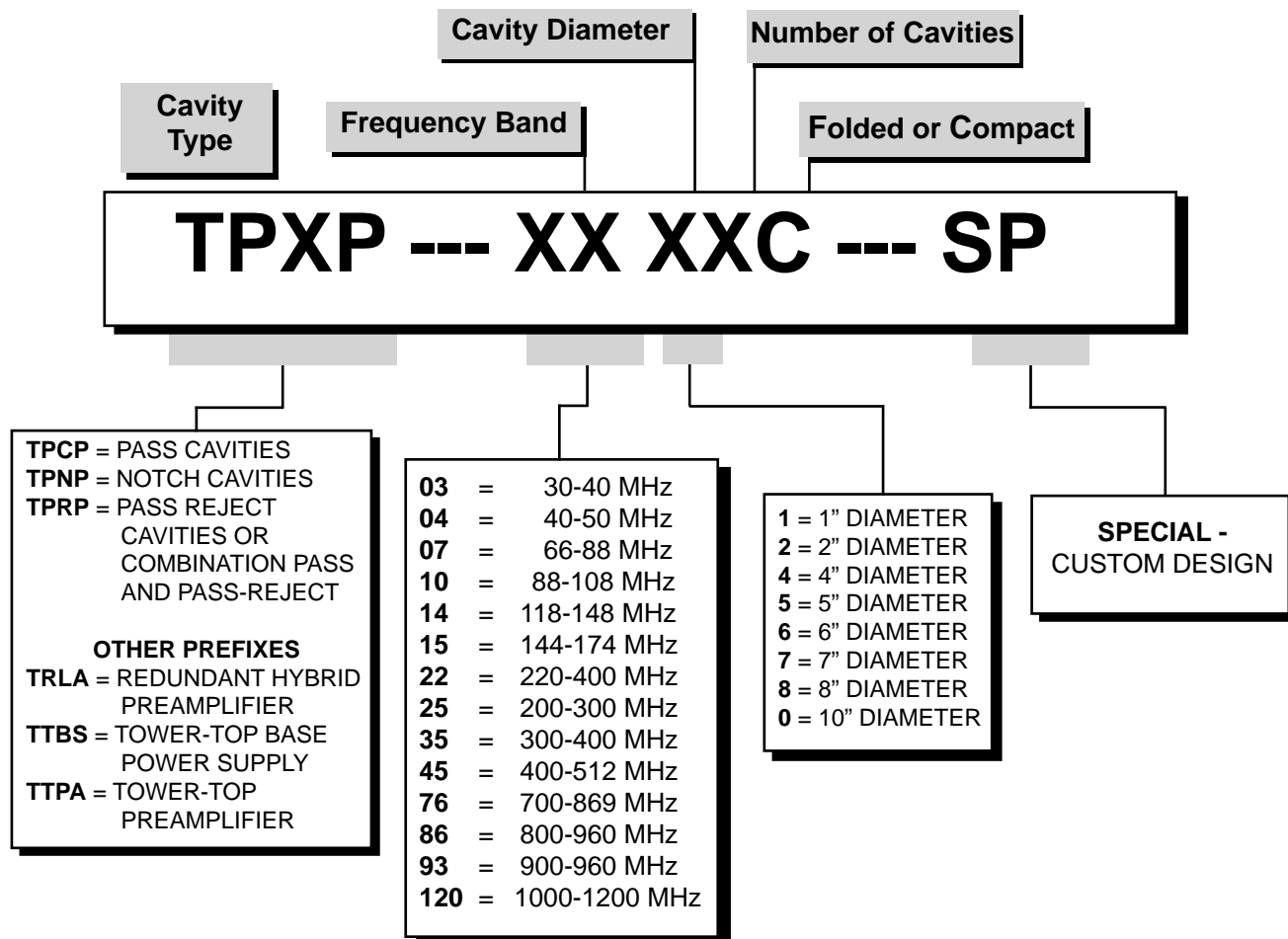

EXAMPLE:

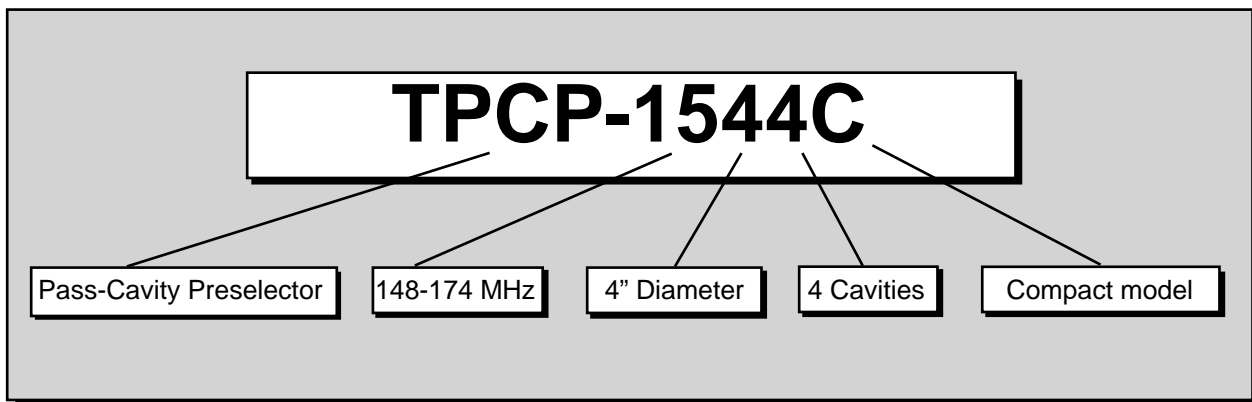

NOTES:

Folded cavities are special coaxial cavities which are about 3/4 as long as a standard 1/4-wave cavity. Folded cavities are required where cavities are mounted on a 19" wide panel. Add 10% to standard pricing for folded cavities. Contact factory for special configurations. Mobile preselectors are provided with BNC connectors. Specify Type N if required.

SECTION 2**PRESELECTORS****RECEIVER PRESELECTORS 70-430 MHz**

Cavity Receiver Preselectors up to 300 MHz are generally strapped together with 19" mounting rails.

Above 300 MHz, cavities are generally mounted on a 19" panel. All square cavities are panel mounted.

MODEL	DESCRIPTION	FREQ. RANGE	CAVITIES DIA. NO.		BAND PASS	GSA PRICE
TPCP-0714	Helical Receiver Preselector	70-90 MHz	1"	4	2 MHz	\$245.25
TPCP-1342C	Pass Cavity Compact Preselector	118-136 MHz	4"	2	700 KHz	\$606.00
TPCP-1343C	Pass Cavity Compact Preselector	118-136 MHz	4"	3	1.5 MHz	\$886.70
TPCP-1344C	Pass Cavity Compact Preselector	118-136 MHz	4"	4	2 MHz	\$1,143.28
TPCP-1454	Pass Cavity Receiver Preselector	118-148 MHz	5"	4	700 KHz	\$815.36
TPCP-1456	Pass Cavity Receiver Preselector	118-148 MHz	5"	6	2 MHz	\$1,276.91
TPCP-1442C	Pass Cavity Compact Preselector	135-151 MHz	4"	2	700 KHz	\$580.41
TPCP-1443C	Pass Cavity Compact Preselector	135-151 MHz	4"	3	1.5 MHz	\$848.33
TPCP-1444C	Pass Cavity Compact Preselector	135-151 MHz	4"	4	2 MHz	\$1,093.58
TPCP-1444CM	Pass Cavity Compact Preselector	135-151 MHz	4"	4	2 MHz	\$1,195.70
TPCP-1446C	Pass Cavity Compact Preselector	135-151 MHz	4"	6	2.2 MHz	\$1,700.67
TPCP-1414	Helical Receiver Preselector	140-150 MHz	1"	1	2 MHz	\$271.79
TPCP-1514	Helical Receiver Preselector	148-174 MHz	1"	4	2 MHz	\$224.34
TPCP-1542C	Pass Cavity Compact Preselector	148-174 MHz	4"	2	700 KHz	\$580.41
TPCP-1543C	Pass Cavity Compact Preselector	148-174 MHz	4"	3	1.5 MHz	\$848.33
TPCP-1544C	Pass Cavity Compact Preselector	148-174 MHz	4"	4	2 MHz	\$1,093.58
TPCP-1544CM	Pass Cavity Compact Preselector	148-174 MHz	4"	4	2 MHz	\$1,195.70
TPCP-1544F	Pass Cavity Receiver Preselector	148-174 MHz	4"	4	800 KHz	\$872.45
TPCP-1546C	Pass Cavity Compact Preselector	148-174 MHz	4"	6	2.2 MHz	\$1,700.67
TPCP-1552	Pass Cavity Receiver Preselector	148-174 MHz	5"	2	250 KHz	\$495.62
TPCP-1554	Pass Cavity Receiver Preselector	148-174 MHz	5"	4	700 KHz	\$815.36
TPCP-1556	Pass Cavity Receiver Preselector	148-174 MHz	5"	6	2 MHz	\$1,276.91
TPCP-2244	Pass Cavity Receiver Preselector	200-300 MHz	4"	4	2 MHz	\$831.44
TPCP-2248	Pass Cavity Receiver Preselector	200-300 MHz	4"	8	4 MHz	\$1,112.07
TPCP-3544	Pass Cavity Receiver Preselector	300-400 MHz	4"	4	2 MHz	\$782.39
TPCP-3546	Pass Cavity Receiver Preselector	300-400 MHz	5"	6	4 MHz	\$1,174.79
TPCP-3548	Pass Cavity Receiver Preselector	300-400 MHz	5"	8	4 MHz	\$1,812.44
TPCP-3844	Pass Cavity Receiver Preselector	370-430 MHz	4"	4	2 MHz	\$1,099.20
TPCP-3846	Pass Cavity Receiver Preselector	370-430 MHz	4"	6	4 MHz	\$1,421.65

SECTION 2**PRESELECTORS****RECEIVER PRESELECTORS 400-960 MHz**

MODEL	DESCRIPTION	FREQ. RANGE	CAVITIES DIA.	NO.	BAND PASS	GSA PRICE
TPCP-4542	Pass Cavity Receiver Preselector	400-512 MHz	4"	2	1 MHz	\$584.58
TPCP-4544	Pass Cavity Receiver Preselector	400-512 MHz	4"	4	2 MHz	\$908.63
TPCP-4546	Pass Cavity Receiver Preselector	400-512 MHz	4"	6	4 MHz	\$1,174.79
TPCP-4548	Pass Cavity Receiver Preselector	400-512 MHz	4"	8	4 MHz	\$1,812.44
TPCP-4514	Helical Receiver Preselector	450-470 MHz	1"	4	4 MHz	\$214.69
TPCP-45215	15 Pole Comblin Preselector	455-460 MHz	2"	15	4 MHz	\$859.58
TPCP-46215	15 Pole Comblin Preselector	465-470 MHz	2"	15	4 MHz	\$859.58
TPCP-45215-2	Dual Window Comblin Preselector Includes TPCP-45215 and TPCP-46215	455-460 MHz 465-470 MHz	2"	15 15	4 MHz 4 MHz	\$1,719.17
TPCP-7642	Pass Cavity Receiver Preselector	763-824 MHz	4"	2	2 MHz	\$643.28
TTPP-7642	Bandpass-Bandreject Receiver Preselector	763-824 MHz	4"	2	5 MHz	\$707.61
TPCP-7644	Pass Cavity Receiver Preselector	763-824 MHz	4"	4	5 MHz	\$908.63
TPCP-8642	Pass Cavity Receiver Preselector	806-960 MHz	4"	2	2 MHz	\$643.28
TTPP-8642	Bandpass-Bandreject Receiver Preselector	806-960 MHz	4"	2	5 MHz	\$567.95
TPCP-8644	Pass Cavity Receiver Preselector	806-960 MHz	4"	4	5 MHz	\$908.63
TPCP-8626	Comblin Receiver Preselector	806-960 MHz	2"	6	15 MHz	\$584.58
TPCP-8626B	Comblin Receiver Preselector	806-821 MHz	2"	6	10 MHz	\$584.58
TPCP-8926B	Comblin Receiver Preselector	824-849 MHz	2"	6	10 MHz	\$584.58
TPCP-8928	Comblin Receiver Preselector	824-849 MHz	2"	8	25 MHz	\$620.77
TPCP-8928-2A	2 Antenna Dual Comblin Preselector	824-849 MHz	2"	16	25 MHz	\$1,732.84
TPCP-9063	Receiver Preselector	806-960 MHz			500 KHz	\$789.63
TPRF-9642	Transmitter sideband filter					\$547.42

SECTION 2

TOWER TOP SERIES

TOWER TOP PREAMPLIFIERS AND PRESELECTORS

Tower Top Preamplifiers and Preselectors are housed in a NEMA 4 standard weather-proof housing. Dimensions are 20" H x 16" W x 10" D unless noted. Pricing may vary depending on filtering requirements. Custom filters such as additional notch bands are available on request.

MODEL	DESCRIPTION	FREQ. RANGE	GSA PRICE
TTPA-3544	Tower Top Preamplifier. 2 MHz BW Preselector with four 4" High-Q cavities. >35dB attenuation at +/-10 MHz F _o . NEMA 4 std. enclosure.	300-400 MHz	\$4,409.39
TTPA-3548	Tower Top Preamplifier. 4 MHz BW Preselector with eight 4" High-Q cavities. >80dB attenuation at +/-10 MHz F _o . NEMA 4 std. enclosure.	300-400 MHz	\$5,409.18
TTPA-4544	Tower Top Preamplifier. 2 MHz BW Preselector with four 4" High-Q cavities. >35dB attenuation at +/-10 MHz F _o . NEMA 4 std. enclosure.	400-512 MHz	\$4,442.65
TTPA-4548	Tower Top Preamplifier. 4 MHz BW Preselector with eight 4" High-Q cavities. >80dB attenuation at +/-10 MHz F _o . NEMA 4 std. enclosure.	400-512 MHz	\$5,409.18
TTPA-4576* TTPA-4586*	Tower Top Preamplifier. Dual Window Preselector with 2 UHF Compline filters crossband-coupled to a 15 MHz Compline filter in the 700 or 800 MHz trunking bands. NEMA 4 enclosure.	400-512 MHz 763-824 MHz 806-869 MHz	Contact Factory
TTPA-45215-2	Tower Top Preamplifier. 4 MHz BW. 2 UHF Compline Preselectors in multi-window configuration. NEMA 4 enclosure.	400-512 MHz	Contact Factory
TTPA-7644	Tower Top Preamplifier. 5 MHz BW Preselector with four 4" High-Q cavities. >35dB attenuation at +/-10 MHz F _o . NEMA 4 std. enclosure.	763-824 MHz	\$4,409.39
TTPA-7648	Tower Top Preamplifier. 5 MHz BW Preselector with eight 4" High-Q cavities. >80dB attenuation at +/- 10 MHz F _o . NEMA 4 std. enclosure.	763-824 MHz	\$5,409.18
TTPA-8626	Tower Top Preamplifier. Includes Compline Preselector with 10, 15, or 20 MHz bandwidth. NEMA 4 enclosure.	806-960 MHz	\$3,684.39
TTPA-8644	Tower Top Preamplifier. 5 MHz BW Preselector with four 4" High-Q cavities. >35dB attenuation at +/- 10 MHz F _o . NEMA 4 std. enclosure.	806-960 MHz	\$4,008.44
TTPA-8648	Tower Top Preamplifier. 5 MHz BW Preselector with eight 4" High-Q cavities. >80dB attenuation at +/- 10 MHz F _o . NEMA 4 std. enclosure.	806-960 MHz	\$4,917.07
TTPA-8690	Tower Top Preamplifier with dual window Preselector for 800/900 MHz trunking bands. NEMA 4 std. enclosure.	806-821 MHz 896-902 MHz	\$4,592.22
TTPA-8926B-A	Cellular Tower Top Preamplifier with dual window Preselector. Passes A Band. Notches B-band . NEMA 4 std. enclosure.	824-835 MHz 845-847 MHz	\$5,148.52
TTPA-8926B-B	Cellular Tower Top Preamplifier with Dual Window Preselector. Passes B Band. Notches A-band . NEMA 4 std. enclosure.	835-845 MHz 847-849 MHz	\$5,148.52
TTPA-8928	Cellular Tower Top Preamplifier. Includes Compline Preselector with 26 MHz bandpass. NEMA 4 enclosure.	824-849 MHz	\$3,758.17
TTBS-4586	Tower Top Base Power Supply (Required for Tower Top Amps)		\$754.25
TTBS-4586A	Tower Top Base Power Supply with Current Alarm Circuit		\$1,058.20
TTBS-4586AB	Tower Top Base Power Supply with Current Alarm Circuit and Step Attenuator		\$1,650.60

* Typical configuration. Other filtering options available depending on requirements.

SECTION 3**POWER MONITORS****POWER MONITORS**

Connectors: RF In / Out - Specify N or UHF. Sampling ports - RCA standard, BNC optional.

MODEL	DESCRIPTION	FREQ. RANGE	GSA PRICE
PM-1A-50	Power Monitor, Single direction 1000 Watts	30-88 MHz	\$78.00
PM-1A-150	Power Monitor, Single direction (50 MHz BW) 1000 Watts	118-230 MHz	\$95.03
PM-1A-300	Power Monitor, Single direction (50 MHz BW) 1000 Watts	200-400 MHz	\$78.00
PM-1A-450	Power Monitor, Single direction (50 MHz BW) 1000 Watts	380-512 MHz	\$95.03
PM-1A-760	Power Monitor, Single direction (50 MHz BW) 1000 Watts	700-869 MHz	\$114.77
PM-1A-900	Power Monitor, Single direction (50 MHz BW) 1000 Watts	806-960 MHz	\$94.88
PM-2A-50	Power Monitor, Dual direction 1000 Watts NSN: 5985013877611	30-88 MHz	\$86.04
PM-2A-150	Power Monitor, Single direction (50 MHz BW) 1000 Watts	118-230 MHz	\$104.53
PM-2A-300	Power Monitor, Dual direction (50 MHz BW) 1000 Watts	200-400 MHz	\$86.04
PM-2A-450	Power Monitor, Single direction (50 MHz BW) 1000 Watts	380-512 MHz	\$104.53
PM-2A-760	Power Monitor, Single direction (50 MHz BW) 1000 Watts	700-869 MHz	\$126.46
PM-2A-900	Power Monitor, Dual direction (50 MHz BW) 1000 Watts	806-960 MHz	\$104.53
TWSC-8940	Single directional coupler. 10% BW. -40dB coupling, 0.1 dB IL., 500 watts, +/-0.2dB flatness. Calibrated to center of required frequency band. N-F connector input and output.	250-960 MHz	\$202.49
TWDC-8940	Dual directional coupler. 10% BW. -40dB coupling, 0.1 dB IL., 500 watts, +/-0.2dB flatness. Calibrated to center of required frequency band. N-F connector in/out, BNC coupler connectors.	250-960 MHz	\$273.39
PMC-250	50 uA unmounted panel meter. Reads 0-250 watts. For use with PM-1A or PM-2A.		\$125.73
PMC-400	50 uA unmounted panel meter. Reads 0-400 watts. For use with PM-1A or PM-2A.		\$125.73
PM8C2S*	Wattmeter Panel for 24" Welded Rack Mounting. Monitors 8 transmitters and 2 antennas, and has 8 transmitter remote keying switches. Specify meter scale.		\$533.12
PM12C3S*	Wattmeter Panel for 24" Welded Rack Mounting. Monitors 12 transmitters and 3 antennas, and has 12 transmitter remote keying switches. Specify meter scale.		\$556.44
PM10C2S1C*	Compact Wattmeter Panel for 19" Rack Mounting. Fits in 1.75" rack space. Monitors 10 transmitters and 2 antennas. 10 TX remote keying switches. Specify meter scale.		\$556.44
PM10C5S*	Wattmeter Panel for 19" Rack Mounting. Monitors 10 transmitters or 5 antennas. 10 transmitter remote keying switches. Specify meter scale.		\$556.44
PM1C1S*	Remote RF Power Monitoring VSWR Alarm Panel for 19" Rack Mounting. Monitors one transmitter and one antenna. Includes one Power Monitor. Specify meter scale.		\$774.35
PM5C1S*	Remote RF Power Monitoring VSWR Alarm Panel for 19" Rack Mounting. Monitors five transmitters and one antenna. (Power monitors not included). Specify meter.		\$1,421.52
PMU2C1S	Remote VSWR/RF power monitoring panel. Monitors output of single or combined transmitters. Digital display, RS-232 or RS-485 signalling. Vertical mount 7.00" x 1.75"		\$2,202.43
PMU2C1S-TM	PMU2C1S with built in modem.		\$2,602.87
PMU2C1S-1R	Remote VSWR/RF power monitoring panel. Monitors output of single or combined transmitters. Digital display, RS-232 or RS-485 signalling. 1.75" x 19" rack mount.		\$2,202.43
PMU2C1S-1RM	PMU2C1S-1R with built in modem.		\$2,602.87
CBL-01	3 ft., 2 conductor cable, RCA Male. Connects power monitor to wattmeter panel.		\$7.24
CBL-02	6 ft., 2 conductor cable, RCA Male. Connects power monitor to wattmeter panel.		\$7.24
CBL-03	12 ft., 2 conductor cable, RCA Male. Connects power monitor to wattmeter panel.		\$7.24

* Specify meter scale 0-250 or 0-400 watts.

SECTION 3

WATTMETERS AND LOADS

BROADBAND WATTMETERS

Wattmeters are supplied standard with N-Female connectors, which are recommended above 500 MHz. Please specify UHF if required. DIN-F optional (additional cost).

MODEL	DESCRIPTION	GSA PRICE
Model 44A	Broadband Wattmeter 20 MHz to 1000 MHz	\$462.16
Model 44AP	Broadband Wattmeter 20 MHz to 1000 MHz. -40 dB sampling port NSN: 6625015510991	\$516.23
Model 44L1	Low Frequency Broadband Wattmeter 2 MHz to 200 MHz NSN: 6625013593978	\$475.22
Model 44L1P	Low Frequency Broadband Wattmeter 2 MHz to 200 MHz. -40 dB sampling port	\$516.23
TC44	Custom carrying case for all Telewave Wattmeters NSN: 6625013594019	\$68.35
QC44B	Quick Change BNC-female connector with 1" flange	\$12.06
QC44D	Quick Change DIN-female connector with 1" flange	\$65.06
QC44N	Quick Change N-female connector with 1" flange	\$12.06
QC44S	Quick Change UHF-female connector with 1" flange	\$12.06
QC44T	Quick Change TNC-female connector with 1" flange	\$12.06

50 OHM COAXIAL LOADS

Loads are supplied standard with N-Female connectors, which are recommended above 500 MHz. Please specify UHF if required. DIN-F optional (additional cost).

MODEL	DESCRIPTION	FREQ. RANGE	CONNECTORS AVAILABLE	POWER (WATTS)	GSA PRICE
TWL-01	Port Termination	0-2500 MHz	N-M, BNC-M	0.1	\$12.87
TWL-35	Coaxial Dry Load	0-1000 MHz	N-M, UHF-M	35	\$63.52
TWL-50	Coaxial Dry Load	0-2500 MHz	N-M/F, UHF-M/F (QC)	50	\$121.42
TWL-60	Coaxial Dry Load NSN: 5985013593878	0-1000 MHz	N-M, UHF-M	60	\$73.98
TWL-75	Coaxial Dry Load	0-2500 MHz	N, UHF M/F, DIN-F (QC)	75	\$124.75
TWL-100	Coaxial Dry Load	0-2500 MHz	N-M/F, UHF-M/F (QC)	100	\$198.61
TWL-100HS	High Standard Termination	0-2500 MHz	N-M/F, UHF-M/F (QC)	100	\$241.23
TWL-100P	Panel Mount Coaxial Load	0-2500 MHz	N-M/F, UHF-M/F (QC)	100	\$327.27
TWL-150	Coaxial Dry Bench Load	0-2500 MHz	N-M/F, UHF-M/F (QC)	150	\$245.25
TWL-300	Coaxial Dry Bench Load	0-1000 MHz	N-F	300	\$455.12
QCLDF	Quick Change Connector for Loads - DIN Female 1-1/4" flange				\$40.94
QCLNM	Quick Change Connector for Loads - N Male 1-1/4" flange				\$10.45
QCLNF	Quick Change Connector for Loads - N Female 1-1/4" flange				\$8.04
QCLSM	Quick Change Connector for Loads - UHF Male 1-1/4" flange				\$12.06
QCLSF	Quick Change Connector for Loads - UHF Female 1-1/4" flange				\$8.85
CO2000	Tele-Dapt 2000 RF Adapter Kit with Carry Case				\$99.71

SECTION 4**ISOLATORS****ISOLATORS**

150 watt Isolators include 35 watt removable loads, and can mount on 19" x 5.25" panels.

200-400 watt Isolators include 60 watt removable loads, and can mount on 19" x 8.75" panels.

MODEL	DESCRIPTION	FREQ. RANGE	ISOLATION	TX POWER	GSA PRICE
T-1030	Single Isolator	66-108 MHz	35 dB	50 W	\$370.69
T-1060	Dual Isolator	66-108 MHz	70 dB	50 W	\$726.91
T-1530	Single Isolator	118-174 MHz	35 dB	100 W	\$370.69
T-1560	Dual Isolator	118-174 MHz	70 dB	100 W	\$726.91
T-1530H	Single Isolator	148-174 MHz	35 dB	300 W	\$991.46
T-1560H	Dual Isolator	148-174 MHz	70 dB	300 W	\$2,343.95
T-2230	Single Isolator	216-250 MHz	35 dB	100 W	\$370.69
T-2260	Dual Isolator	216-250 MHz	70 dB	100 W	\$726.91
T-3530	Single Isolator	300-400 MHz	35 dB	150 W	\$370.69
T-3560	Dual Isolator	300-400 MHz	70 dB	150 W	\$726.91
T-4530	Single Isolator	400-512 MHz	35 dB	150 W	\$370.69
T-4560	Dual Isolator	400-512 MHz	70 dB	150 W	\$726.91
T-4530H	Single Isolator	440-475 MHz	35 dB	400 W	\$484.07
T-4560H	Dual Isolator	440-475 MHz	70 dB	400 W	\$928.74
T-7530	Single Isolator	700-806 MHz	35 dB	150 W	\$407.68
T-7560	Dual Isolator	700-806 MHz	70 dB	150 W	\$798.98
T-8630	Single Isolator	806-960 MHz	35 dB	150 W	\$370.69
T-8660	Dual Isolator	806-960 MHz	70 dB	150 W	\$726.91
T-8660H	Dual Isolator	806-960 MHz	70 dB	300 W	\$836.26
T-1030CM	Single isolator - cavity mount. With 35 watt removable load.	66-108 MHz	35 dB	50 W	\$432.53
T-1060CM	Dual isolator - cavity mount. Two 35 watt removable loads.	66-108 MHz	70 dB	50 W	\$779.70
T-1530CM	Single isolator - cavity mount. With 35 watt removable load.	118-174 MHz	35 dB	100 W	\$432.53
T-1560CM	Dual isolator - cavity mount. Two 35 watt removable loads.	118-174 MHz	70 dB	100 W	\$779.70
T-4530CM	Single isolator - cavity mount. With 35 watt removable load.	400-512 MHz	35 dB	150 W	\$432.53
T-4560CM	Dual isolator - cavity mount. Two 35 watt removable loads.	400-512 MHz	70 dB	150 W	\$779.70

NOTES:

- 1) Please specify exact operating frequency and connector type with order.
- 2) Higher power handling available. Contact factory with requirements.

SECTION 4

I.M. SUPPRESSION PANELS

INTERMODULATION SUPPRESSION PANELS

Intermod panels mount on 19" rack. 150 watt models are 5.25" high, 300-400 watt models are 8.75" high. Power handling: 50 or 100 watts reflected, 150-400 watts forward. 150 and 300 watt output loads available. Contact factory for pricing.

MODEL	DESCRIPTION	FREQ. RANGE	ISOLATION	TX POWER	GSA PRICE
TS150PA1	Single Isolator with Filter - 50 W Load	118-174 MHz	35 dB	100 W	\$585.38
TS150PB1	Dual Isolator with Filter - 50 W Load	118-174 MHz	70 dB	100 W	\$928.74
TS150PA2	Single Isolator with Filter - 100 W Load	148-174 MHz	35 dB	300 W	\$1,221.43
TS150PB2	Dual Isolator with Filter - 100 W Load	148-174 MHz	70 dB	300 W	\$2,155.79
TS220PA1	Single Isolator with Filter - 50 W Load	216-250 MHz	35 dB	100 W	\$585.38
TS220PB1	Dual Isolator with Filter - 50 W Load	216-250 MHz	70 dB	100 W	\$928.74
TS350PA1	Single Isolator with Filter - 50 W Load	300-400 MHz	35 dB	150 W	\$644.01
TS350PB1	Dual Isolator with Filter - 50 W Load	300-400 MHz	70 dB	150 W	\$1,021.94
TS450PA1	Single Isolator with Filter - 50 W Load	406-512 MHz	35 dB	150 W	\$585.38
TS450PB1	Dual Isolator with Filter - 50 W Load	406-512 MHz	70 dB	150 W	\$928.74
TS450PA2	Single Isolator with Filter - 100 W Load	440-475 MHz	35 dB	400 W	\$746.20
TS450PB2	Dual Isolator with Filter - 100 W Load	440-475 MHz	70 dB	400 W	\$1,166.75
TS760PA1	Single Isolator with Filter - 50 W Load	734-869 MHz	35 dB	150 W	\$689.33
TS760PB1	Dual Isolator with Filter - 50 W Load	734-869 MHz	70 dB	150 W	\$1,115.51
TS760PB2	Dual Isolator with Filter - 100 W Load	734-869 MHz	70 dB	300 W	\$1,324.57
TS900PA1	Single Isolator with Filter - 50 W Load	806-960 MHz	35 dB	150 W	\$626.39
TS900PB1	Dual Isolator with Filter - 50 W Load	806-960 MHz	70 dB	150 W	\$1,013.97
TS900PB2	Dual Isolator with Filter - 100 W Load	806-960 MHz	70 dB	300 W	\$1,203.74

HIGH PERFORMANCE REPEATER PANELS

Each panel includes integrated duplexer, receiver preamplifier, preselector, low pass filter and dual isolator.

MODEL	DESCRIPTION	FREQ. RANGE	ISOLATION	TX POWER	GSA PRICE
THRP-1548	High Performance Repeater Panel	144-172 MHz	60 dB	125 W	\$2,977.58
THRP-4548	High Performance Repeater Panel	406-512 MHz	60 dB	125 W	\$2,819.17
THRP-7648	High Performance Repeater Panel	763-869 MHz	60 dB	125 W	\$3,101.63
THRP-8648	High Performance Repeater Panel	806-960 MHz	60 dB	125 W	\$2,819.17

CAVITIES AND FILTERS MODEL NUMBER NOMENCLATURE

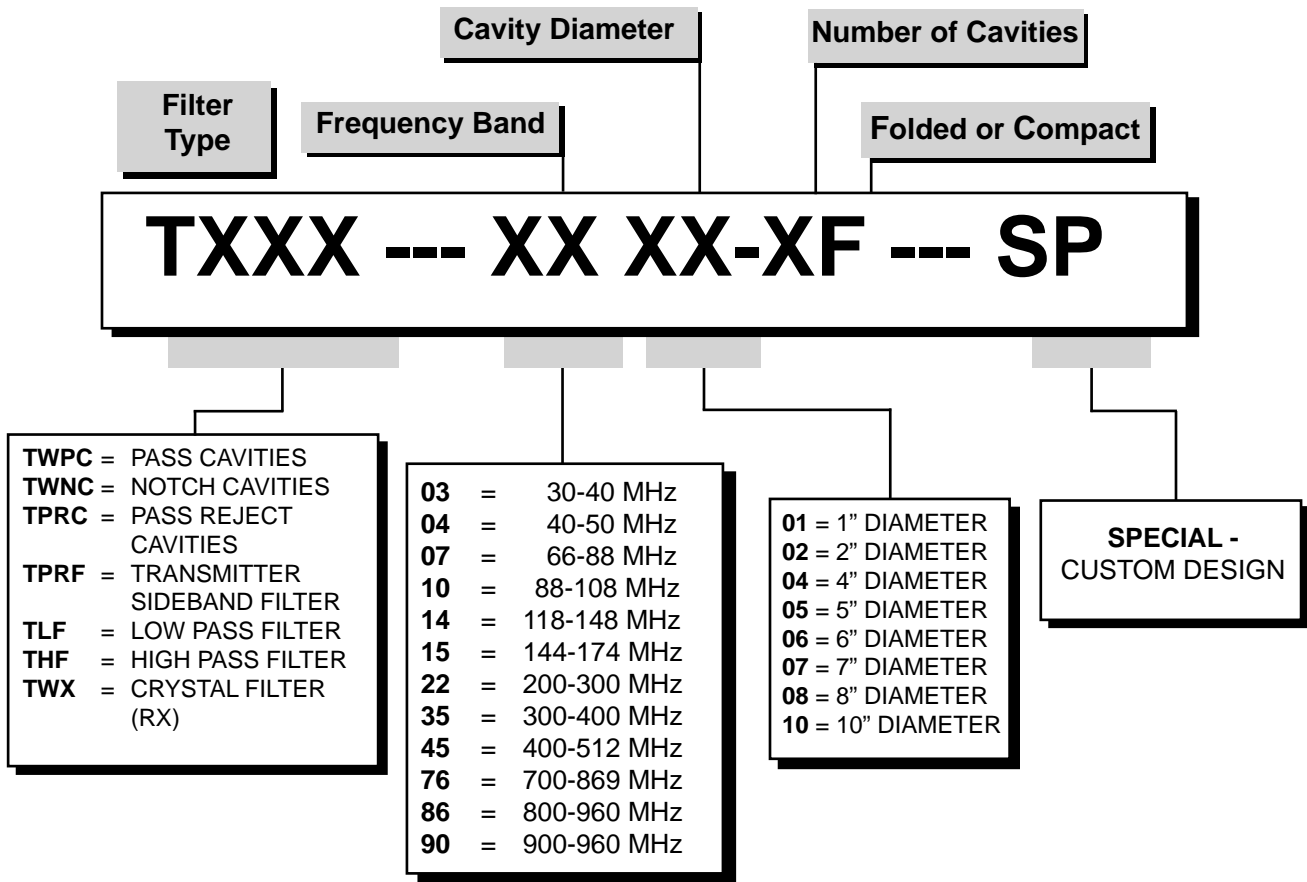

EXAMPLE:

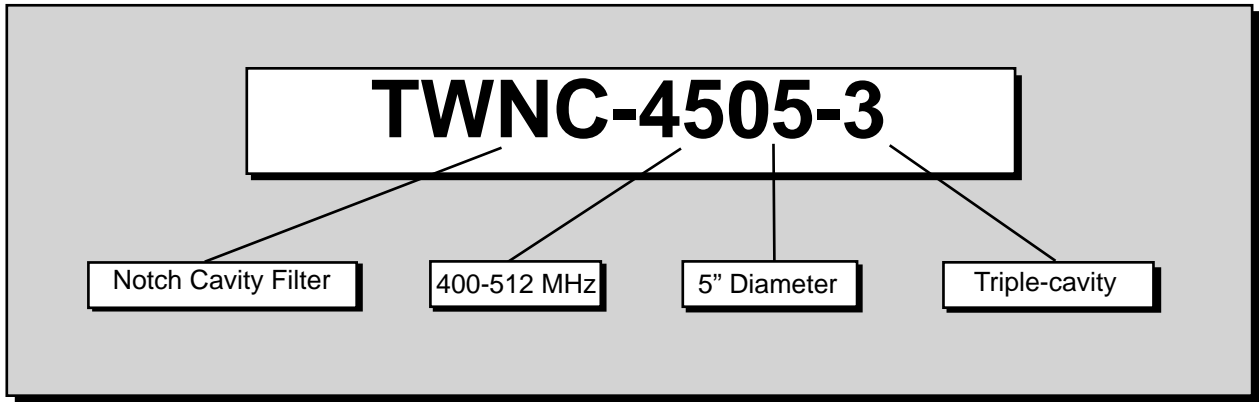

NOTES:
 Folded cavities are special coaxial cavities which are about 3/4 as long as a standard 1/4-wave cavity. Folded cavities are required where cavities are mounted on a 19" wide panel. Add 10% to standard pricing for folded cavities. Contact factory for special configurations.

SECTION 5**CAVITIES****BANDPASS/REJECT CAVITIES WITH ADJUSTABLE COUPLING - 30-960 MHz**

Prices include interconnect cables and mounting rails or panels for multiple cavities.

N connectors standard. Specify UHF if required. 7-16 DIN available at extra cost.

All cavities are factory tuned to customer-specified frequencies. 75 ohm cavities available on request.

MODEL	FREQ.	DESCR.	DIA.	GSA PR.
TPRC-0305-1	30-40	Single Cavity	5"	\$527.49
TPRC-0305-2	30-40	Dual Cavity	5"	\$1,084.73
TPRC-0308-1	30-40	Single Cavity	8"	\$642.48
TPRC-0308-2	30-40	Dual Cavity	8"	\$1,313.90
TPRC-0310-1	30-40	Single Cavity	10"	\$750.23
TPRC-0310-2	30-40	Dual Cavity	10"	\$1,528.59
TPRC-0405-1	40-50	Single Cavity	5"	\$422.96
TPRC-0405-2	40-50	Dual Cavity	5"	\$854.76
TPRC-0408-1	40-50	Single Cavity	8"	\$534.73
TPRC-0408-2	40-50	Dual Cavity	8"	\$1,099.20
TPRC-0410-1	40-50	Single Cavity	10"	\$642.48
TPRC-0410-2	40-50	Dual Cavity	10"	\$1,313.90
TPRC-0705-1	66-88	Single Cavity	5"	\$263.74
TPRC-0705-2	66-88	Dual Cavity	5"	\$557.24
TPRC-0708-1	66-88	Single Cavity	8"	\$357.02
TPRC-0708-2	66-88	Dual Cavity	8"	\$743.79
TPRC-0710-1	66-88	Single Cavity	10"	\$414.11
TPRC-0710-2	66-88	Dual Cavity	10"	\$857.17
TPRC-1005-1	88-108	Single Cavity	5"	\$199.42
TPRC-1005-2	88-108	Dual Cavity	5"	\$426.98
TPRC-1008-1	88-108	Single Cavity	8"	\$285.46
TPRC-1008-2	88-108	Dual Cavity	8"	\$600.66
TPRC-1405-1	118-148	Single Cavity	5"	\$199.42
TPRC-1405-2	118-148	Dual Cavity	5"	\$426.98
TPRC-1408-1	118-148	Single Cavity	8"	\$285.46
TPRC-1408-2	118-148	Dual Cavity	8"	\$600.66
TPRC-1410-1	118-148	Single Cavity	10"	\$322.44
TPRC-1410-2	118-148	Dual Cavity	10"	\$673.03
TPRC-1505-1	148-174	Single Cavity	5"	\$194.59
TPRC-1505-2	148-174	Dual Cavity	5"	\$415.72
TPRC-1505-3	148-174	Triple Cavity	5"	\$639.26
TPRC-1508-1	148-174	Single Cavity	8"	\$271.79
TPRC-1508-2	148-174	Dual Cavity	8"	\$572.52
TPRC-1508-3	148-174	Triple Cavity	8"	\$870.84
TPRC-1510-1	148-174	Single Cavity	10"	\$341.74
TPRC-1510-2	148-174	Dual Cavity	10"	\$713.24
TPRC-1510-3	148-174	Triple Cavity	10"	\$1,083.93
TBC-40	Upright Cabinet - Indoor			\$602.42

MODEL	FREQ.	DESCR.	DIA.	GSA PR.
TPRC-2204-1	200-300	Single Cavity	4"	\$228.36
TPRC-2204-2	200-300	Dual Cavity	4"	\$486.48
TPRC-2205-1	200-300	Single Cavity	5"	\$194.59
TPRC-2205-2	200-300	Dual Cavity	5"	\$415.72
TPRC-2208-1	200-300	Single Cavity	8"	\$271.79
TPRC-2208-2	200-300	Dual Cavity	8"	\$572.52
TPRC-2210-1	200-300	Single Cavity	10"	\$307.97
TPRC-2210-2	200-300	Dual Cavity	10"	\$644.89
TPRC-3504-1	300-400	Single Cavity	4"	\$268.28
TPRC-3504-2	300-400	Dual Cavity	4"	\$561.41
TPRC-3504-3	300-400	Triple Cavity	4"	\$838.46
TPRC-3507-1	300-400	Single Cavity	7"	\$291.67
TPRC-3507-2	300-400	Dual Cavity	7"	\$609.65
TPRC-3507-3	300-400	Triple Cavity	7"	\$918.87
TPRC-3508-1	300-400	Single Cavity	8"	\$309.94
TPRC-3508-2	300-400	Dual Cavity	8"	\$634.51
TPRC-3508-3	300-400	Triple Cavity	8"	\$967.84
TPRC-4504-1	400-512	Single Cavity	4"	\$209.07
TPRC-4504-2	400-512	Dual Cavity	4"	\$446.28
TPRC-4504-3	400-512	Triple Cavity	4"	\$681.88
TPRC-4508-1	400-512	Single Cavity	8"	\$228.36
TPRC-4508-2	400-512	Dual Cavity	8"	\$486.48
TPRC-4508-3	400-512	Triple Cavity	8"	\$744.60
TPRC-4510-1	400-512	Single Cavity	10"	\$271.79
TPRC-4510-2	400-512	Dual Cavity	10"	\$572.52
TPRC-4510-3	400-512	Triple Cavity	10"	\$872.45
TPRC-7604-1	763-869	Single Cavity	4"	\$253.66
TPRC-7604-2	763-869	Dual Cavity	4"	\$540.21
TPRC-7604-3	763-869	Triple Cavity	4"	\$828.22
TPRC-7608-1	763-869	Single Cavity	8"	\$275.59
TPRC-7608-2	763-869	Dual Cavity	8"	\$589.92
TPRC-8604-1	800-960	Single Cavity	4"	\$209.07
TPRC-8604-2	800-960	Dual Cavity	4"	\$446.28
TPRC-8604-3	800-960	Triple Cavity	4"	\$684.29
TPRC-8608-1	800-960	Single Cavity	8"	\$228.36
TPRC-8608-2	800-960	Dual Cavity	8"	\$486.48

SECTION 5**CAVITIES****BANDPASS CAVITIES WITH ADJUSTABLE COUPLING - 30-960 MHz**

Prices include interconnect cables and mounting rails or panels for multiple cavities.

N connectors standard. Specify UHF if required. 7-16 DIN available at extra cost.

All cavities are factory tuned to customer-specified frequencies. 75 ohm cavities available on request.

MODEL	FREQ.	DESCR.	DIA.	GSA PR.	MODEL	FREQ.	DESCR.	DIA.	GSA PR.
TWPC-0305-1	30-40	Single Cavity	5"	\$527.49	TWPC-2205-1	200-300	Single Cavity	5"	\$194.59
TWPC-0305-2	30-40	Dual Cavity	5"	\$1,084.73	TWPC-2205-2	200-300	Dual Cavity	5"	\$415.72
TWPC-0308-1	30-40	Single Cavity	8"	\$642.48	TWPC-2205-3	200-300	Triple Cavity	5"	\$622.12
TWPC-0308-2	30-40	Dual Cavity	8"	\$1,313.90	TWPC-2208-1	200-300	Single Cavity	8"	\$271.79
TWPC-0310-1	30-40	Single Cavity	10"	\$750.23	TWPC-2208-2	200-300	Dual Cavity	8"	\$572.52
TWPC-0310-2	30-40	Dual Cavity	10"	\$1,528.59	TWPC-2210-1	200-300	Single Cavity	10"	\$307.97
TWPC-0405-1	40-50	Single Cavity	5"	\$422.96	TWPC-2210-2	200-300	Dual Cavity	10"	\$644.89
TWPC-0405-2	40-50	Dual Cavity	5"	\$854.76	TWPC-3504-1	300-400	Single Cavity	4"	\$268.28
TWPC-0408-1	40-50	Single Cavity	8"	\$534.73	TWPC-3504-2	300-400	Dual Cavity	4"	\$561.41
TWPC-0408-2	40-50	Dual Cavity	8"	\$1,099.20	TWPC-3504-3	300-400	Triple Cavity	4"	\$838.46
TWPC-0410-1	40-50	Single Cavity	10"	\$642.48	TWPC-3507-1	300-400	Single Cavity	7"	\$291.67
TWPC-0410-2	40-50	Dual Cavity	10"	\$1,313.90	TWPC-3507-2	300-400	Dual Cavity	7"	\$609.65
TWPC-0705-1	66-88	Single Cavity	5"	\$263.74	TWPC-3507-3	300-400	Triple Cavity	7"	\$918.87
TWPC-0705-2	66-88	Dual Cavity	5"	\$557.24	TWPC-3508-1	300-400	Single Cavity	8"	\$309.94
TWPC-0708-1	66-88	Single Cavity	8"	\$357.02	TWPC-3508-2	300-400	Dual Cavity	8"	\$634.51
TWPC-0708-2	66-88	Dual Cavity	8"	\$743.79	TWPC-3508-3	300-400	Triple Cavity	8"	\$967.84
TWPC-0710-1	66-88	Single Cavity	10"	\$414.11	TWPC-4504-1	400-512	Single Cavity	4"	\$209.07
TWPC-0710-2	66-88	Dual Cavity	10"	\$857.17	TWPC-4504-2	400-512	Dual Cavity	4"	\$446.28
TWPC-1005-1	88-108	Single Cavity	5"	\$199.42	TWPC-4504-3	400-512	Triple Cavity	4"	\$681.88
TWPC-1005-2	88-108	Dual Cavity	5"	\$426.98	TWPC-4505-1	400-512	Single Cavity	5"	\$185.75
TWPC-1005-3	88-108	Triple Cavity	5"	\$656.95	TWPC-4505-2	400-512	Dual Cavity	5"	\$400.44
TWPC-1008-1	88-108	Single Cavity	8"	\$285.46	TWPC-4505-3	400-512	Triple Cavity	5"	\$613.53
TWPC-1008-2	88-108	Dual Cavity	8"	\$600.66	TWPC-4508-1	400-512	Single Cavity	8"	\$228.36
TWPC-1405-1	118-148	Single Cavity	5"	\$199.42	TWPC-4508-2	400-512	Dual Cavity	8"	\$400.44
TWPC-1405-2	118-148	Dual Cavity	5"	\$426.98	TWPC-4508-3	400-512	Triple Cavity	8"	\$744.60
TWPC-1408-1	118-148	Single Cavity	8"	\$285.46	TWPC-4510-1	400-512	Single Cavity	10"	\$271.79
TWPC-1408-2	118-148	Dual Cavity	8"	\$600.66	TWPC-4510-2	400-512	Dual Cavity	10"	\$572.52
TWPC-1410-1	118-148	Single Cavity	10"	\$322.44	TWPC-4510-3	400-512	Triple Cavity	10"	\$872.45
TWPC-1410-2	118-148	Dual Cavity	10"	\$673.03	TWPC-7604-1	763-869	Single Cavity	4"	\$253.66
TWPC-1505-1	148-174	Single Cavity	5"	\$194.59	TWPC-7604-2	763-869	Dual Cavity	4"	\$540.21
TWPC-1505-2	148-174	Dual Cavity	5"	\$415.72	TWPC-7604-3	763-869	Triple Cavity	4"	\$828.22
TWPC-1505-3	148-174	Triple Cavity	5"	\$639.26	TWPC-7608-1	763-869	Single Cavity	8"	\$275.59
TWPC-1508-1	148-174	Single Cavity	8"	\$271.79	TWPC-7608-2	763-869	Dual Cavity	8"	\$589.92
TWPC-1508-2	148-174	Dual Cavity	8"	\$572.52	TWPC-8604-1	800-960	Single Cavity	4"	\$209.07
TWPC-1508-3	148-174	Triple Cavity	8"	\$870.84	TWPC-8604-2	800-960	Dual Cavity	4"	\$446.28
TWPC-1510-1	148-174	Single Cavity	10"	\$341.74	TWPC-8604-3	800-960	Triple Cavity	4"	\$684.29
TWPC-1510-2	148-174	Dual Cavity	10"	\$713.24	TWPC-8608-1	800-960	Single Cavity	8"	\$228.36
TWPC-1510-3	148-174	Triple Cavity	10"	\$1,083.93	TWPC-8608-2	800-960	Dual Cavity	8"	\$486.48
TBC-40	Upright Cabinet - Indoor			\$602.42					

SECTION 5**CAVITIES****NOTCH CAVITIES WITH ADJUSTABLE COUPLING - 30-960 MHz**

Prices include interconnect cables and mounting rails or panels for multiple cavities.

N connectors standard. Specify UHF if required. 7-16 DIN available at extra cost.

All cavities are factory tuned to customer-specified frequencies. 75 ohm cavities available on request.

MODEL	FREQ.	DESCR.	DIA.	GSA PR.	MODEL	FREQ.	DESCR.	DIA.	GSA PR.
TWNC-0305-1	30-40	Single Cavity	5"	\$527.49	TWNC-2204-1	200-300	Single Cavity	4"	\$228.36
TWNC-0305-2	30-40	Dual Cavity	5"	\$1,084.73	TWNC-2204-2	200-300	Dual Cavity	4"	\$486.48
TWNC-0308-1	30-40	Single Cavity	8"	\$642.48	TWNC-2205-1	200-300	Single Cavity	5"	\$194.59
TWNC-0308-2	30-40	Dual Cavity	8"	\$1,313.90	TWNC-2205-2	200-300	Dual Cavity	5"	\$415.72
TWNC-0310-1	30-40	Single Cavity	10"	\$750.23	TWNC-2208-1	200-300	Single Cavity	8"	\$271.79
TWNC-0310-2	30-40	Dual Cavity	10"	\$1,528.59	TWNC-2208-2	200-300	Dual Cavity	8"	\$572.52
TWNC-0405-1	40-50	Single Cavity	5"	\$422.96	TWNC-3504-1	300-400	Single Cavity	4"	\$268.28
TWNC-0405-2	40-50	Dual Cavity	5"	\$854.76	TWNC-3504-2	300-400	Dual Cavity	4"	\$561.41
TWNC-0408-1	40-50	Single Cavity	8"	\$534.73	TWNC-3504-3	300-400	Triple Cavity	4"	\$838.46
TWNC-0408-2	40-50	Dual Cavity	8"	\$1,099.20	TWNC-3507-1	300-400	Single Cavity	7"	\$291.67
TWNC-0410-1	40-50	Single Cavity	10"	\$642.48	TWNC-3507-2	300-400	Dual Cavity	7"	\$609.65
TWNC-0410-2	40-50	Dual Cavity	10"	\$1,313.90	TWNC-3507-3	300-400	Triple Cavity	7"	\$918.87
TWNC-0705-1	66-88	Single Cavity	5"	\$263.74	TWNC-3508-1	300-400	Single Cavity	8"	\$309.94
TWNC-0705-2	66-88	Dual Cavity	5"	\$557.24	TWNC-3508-2	300-400	Dual Cavity	8"	\$634.51
TWNC-0708-1	66-88	Single Cavity	8"	\$357.02	TWNC-3508-3	300-400	Triple Cavity	8"	\$967.84
TWNC-0708-2	66-88	Dual Cavity	8"	\$743.79	TWNC-4504-1	400-512	Single Cavity	4"	\$209.07
TWNC-0710-1	66-88	Single Cavity	10"	\$414.11	TWNC-4504-2	400-512	Dual Cavity	4"	\$446.28
TWNC-0710-2	66-88	Dual Cavity	10"	\$857.17	TWNC-4504-3	400-512	Triple Cavity	4"	\$681.88
TWNC-1005-1	88-108	Single Cavity	5"	\$199.42	TWNC-4505-1	400-512	Single Cavity	5"	\$185.75
TWNC-1005-2	88-108	Dual Cavity	5"	\$426.98	TWNC-4505-2	400-512	Dual Cavity	5"	\$400.44
TWNC-1008-1	88-108	Single Cavity	8"	\$277.41	TWNC-4505-3	400-512	Triple Cavity	5"	\$613.53
TWNC-1008-2	88-108	Dual Cavity	8"	\$600.66	TWNC-4508-1	400-512	Single Cavity	8"	\$228.36
TWNC-1405-1	118-148	Single Cavity	5"	\$199.42	TWNC-4508-2	400-512	Dual Cavity	8"	\$486.48
TWNC-1405-2	118-148	Dual Cavity	5"	\$426.98	TWNC-4510-1	400-512	Single Cavity	10"	\$271.79
TWNC-1408-1	118-148	Single Cavity	8"	\$285.46	TWNC-4510-2	400-512	Dual Cavity	10"	\$572.52
TWNC-1408-2	118-148	Dual Cavity	8"	\$600.66	TWNC-7604-1	763-869	Single Cavity	4"	\$253.66
TWNC-1410-1	118-148	Single Cavity	10"	\$322.44	TWNC-7604-2	763-869	Dual Cavity	4"	\$540.21
TWNC-1410-2	118-148	Dual Cavity	10"	\$673.03	TWNC-7604-3	763-869	Triple Cavity	4"	\$828.22
TWNC-1505-1	148-174	Single Cavity	5"	\$194.59	TWNC-7608-1	763-869	Single Cavity	8"	\$275.59
TWNC-1505-2	148-174	Dual Cavity	5"	\$415.72	TWNC-7608-2	763-869	Dual Cavity	8"	\$589.92
TWNC-1505-3	148-174	Triple Cavity	5"	\$639.26	TWNC-8604-1	800-960	Single Cavity	4"	\$209.07
TWNC-1508-1	148-174	Single Cavity	8"	\$271.79	TWNC-8604-2	800-960	Dual Cavity	4"	\$446.28
TWNC-1508-2	148-174	Dual Cavity	8"	\$572.52	TWNC-8604-3	800-960	Triple Cavity	4"	\$684.29
TWNC-1508-3	148-174	Triple Cavity	8"	\$870.84	TWNC-8608-1	800-960	Single Cavity	8"	\$228.36
TWNC-1510-1	148-174	Single Cavity	10"	\$341.74	TWNC-8608-2	800-960	Dual Cavity	8"	\$486.48
TWNC-1510-2	148-174	Dual Cavity	10"	\$713.24					
TWNC-1510-3	148-174	Triple Cavity	10"	\$1,083.93					
TBC-40	Upright Cabinet - Indoor			\$602.42					

SECTION 5

FILTERS

TRANSMITTER AND RECEIVER FILTERS

Specify N, UHF, or BNC connectors. Contact factory for quotation on filters outside listed frequency ranges.

LOW PASS

MODEL	DESCRIPTION	FREQ. RANGE	POWER WATTS	GSA PRICE
TLF-50	Low Pass Transmitter Filter	40-54 MHz	200	\$127.85
TLF-90	Low Pass Transmitter Filter	88-108 MHz	200	\$127.85
TLF-90H	Low Pass Transmitter Filter - HP	88-108 MHz	1000	\$255.70
TLF-150	Low Pass Transmitter Filter	144-174 MHz	400	\$127.85
TLF-450	Low Pass Transmitter Filter	406-512 MHz	200	\$127.85
TLF-760	Low Pass Transmitter Filter	763-824 MHz	200	\$154.97
TLF-860	Low Pass Transmitter Filter	806-960 MHz	200	\$127.85

HIGH PASS

MODEL	DESCRIPTION	FREQ. RANGE	POWER WATTS	GSA PRICE
THF-150	High Pass Transmitter Filter	144-174 MHz	25	\$127.85
THF-450	High Pass Transmitter Filter	406-512 MHz	25	\$127.85
THF-760	High Pass Transmitter Filter	763-869 MHz	25	\$154.97
THF-860	High Pass Transmitter Filter	806-960 MHz	25	\$127.85

RECEIVER CRYSTAL FILTERS

Crystal filters normally require more time to manufacture than other system components.

System delivery time may be extended if crystal filters are ordered as part of a system.

Please contact the factory for assistance with delivery schedules.

MODEL	DESCRIPTION	FREQUENCY	POWER WATTS	GSA PRICE
TWX50*	Receiver Crystal Filter, 50 MHz Band	Specify	0.001	\$864.41
TWX150*	Receiver Crystal Filter, 150 MHz Band	Specify	0.001	\$864.41

DUPLEXER MODEL NUMBER NOMENCLATURE

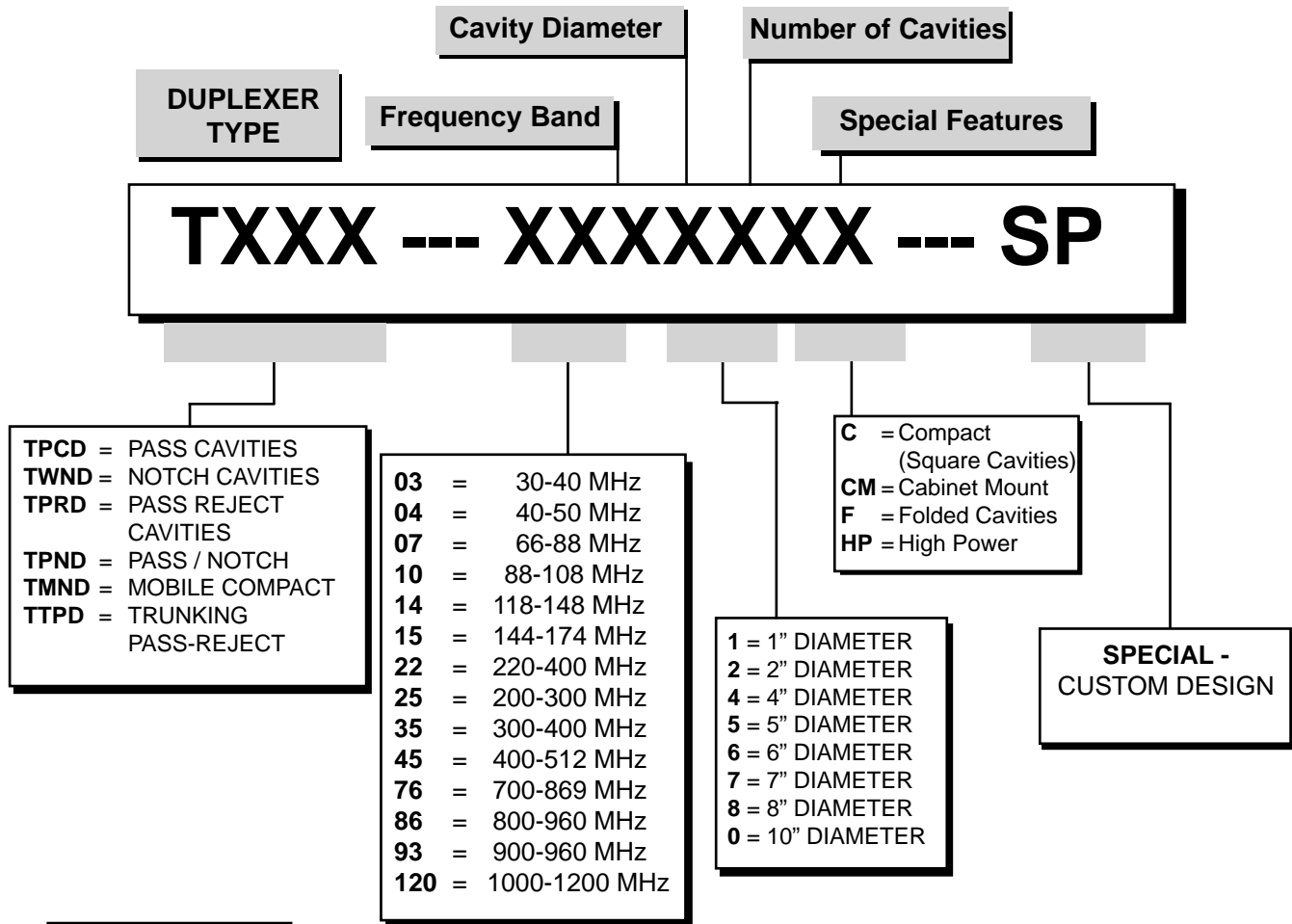

EXAMPLE:

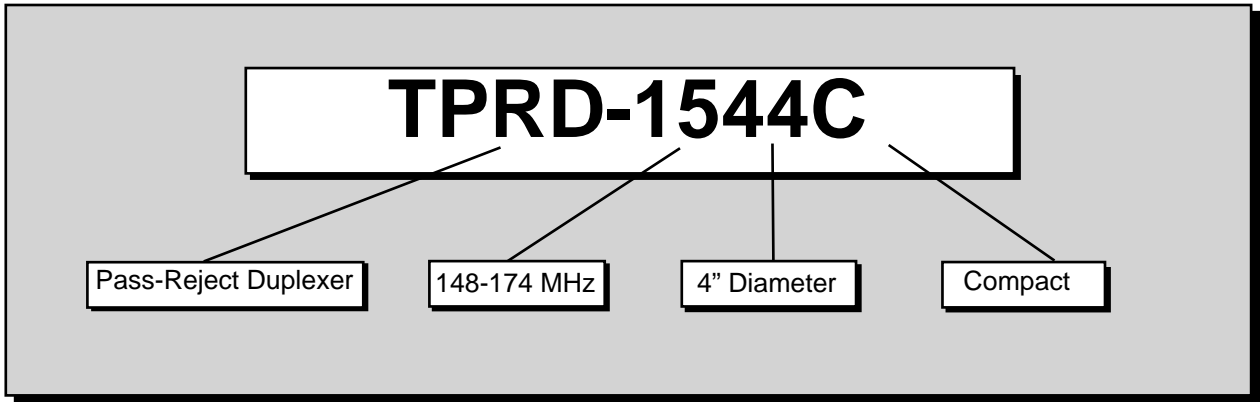

NOTES:
 Folded cavities are special coaxial cavities which are about 3/4 as long as a standard 1/4-wave cavity. Folded cavities are required where cavities are mounted on a 19" wide panel. Add 10% to standard pricing for folded cavities. Contact factory for special configurations. Mobile duplexers are provided with BNC connectors. Specify Type N if required.

SECTION 6**DUPLEXERS****BASE STATION DUPLEXERS 30-430 MHz**

Prices include interconnect cables and mounting rails or panels. Specify N, UHF, or 7-16 DIN connectors (option).

All duplexers are factory tuned to specified pass and reject frequencies. Custom configurations such as additional pass or notch filters available on request.

MODEL	DESCRIPTION	FREQ. RANGE	CAVITIES DIA.	NO.	MINIMUM SPACING	GSA PRICE
TPRD-0354	Pass-Reject Base Station Duplexer	30-40 MHz	5"	4	600 KHz	\$2,146.14
TPRD-0356	Pass-Reject Base Station Duplexer	30-40 MHz	5"	6	300 KHz	\$3,217.20
TPRD-0384	Pass-Reject Base Station Duplexer	30-40 MHz	8"	4	300 KHz	\$2,602.07
TPRD-0304	Pass-Reject Base Station Duplexer	30-40 MHz	10"	4	275 KHz	\$3,029.85
TPRD-0454	Pass-Reject Base Station Duplexer	40-50 MHz	5"	4	600 KHz	\$1,719.17
TPRD-0456	Pass-Reject Base Station Duplexer	40-50 MHz	5"	6	300 KHz	\$2,576.34
TPRD-0484	Pass-Reject Base Station Duplexer	40-50 MHz	8"	4	300 KHz	\$2,175.09
TPRD-0404	Pass-Reject Base Station Duplexer	40-50 MHz	10"	4	275 KHz	\$2,615.74
TPRD-0754	Pass-Reject Base Station Duplexer	60-88 MHz	5"	4	600 KHz	\$1,091.16
TPRD-0756	Pass-Reject Base Station Duplexer	60-88 MHz	5"	6	300 KHz	\$1,568.80
TPRD-0784	Pass-Reject Base Station Duplexer	60-88 MHz	8"	4	300 KHz	\$1,461.85
TPRD-0704	Pass-Reject Base Station Duplexer	60-88 MHz	10"	4	275 KHz	\$1,688.61
TPRD-1054	Pass-Reject Base Station Duplexer	88-108 MHz	5"	4	600 KHz	\$1,320.19
TPRD-1056	Pass-Reject Base Station Duplexer	88-108 MHz	5"	6	300 KHz	\$1,898.41
TPRD-1084	Pass-Reject Base Station Duplexer	88-108 MHz	8"	4	300 KHz	\$1,769.02
TPRD-1344C	Compact Pass Reject Base Duplexer	118-136 MHz	4"	4	600 KHz	\$1,186.05
TPRD-1454	Pass-Reject Base Station Duplexer	118-148 MHz	5"	4	600 KHz	\$820.18
TPRD-1484	Pass-Reject Base Station Duplexer	118-148 MHz	8"	4	500 KHz	\$1,198.11
TPRD-1486	Pass-Reject Base Station Duplexer	118-148 MHz	8"	6	300 KHz	\$1,797.16
TPRD-1444C	Compact Pass Reject Base Duplexer	135-151 MHz	4"	4	600 KHz	\$1,134.51
TPRD-1444CM	Compact Pass Reject Base Duplexer	135-151 MHz	4"	4	600 KHz	\$1,236.71
TPRD-1446C	Compact Pass Reject Base Duplexer	135-151 MHz	4"	6	500 KHz	\$1,700.67
TPRD-1544C	Compact Pass Reject Base Duplexer	148-174 MHz	4"	4	600 KHz	\$1,134.51
TPRD-1544CM	Compact Pass Reject Base Duplexer	148-174 MHz	4"	4	600 KHz	\$1,236.71
TPRD-1544F	Pass-Reject Base Station Duplexer	148-174 MHz	4"	4	2 MHz	\$883.71
TPRD-1546C	Compact Pass Reject Base Duplexer	148-174 MHz	4"	6	500 KHz	\$1,700.67
TPRD-1554	Pass-Reject Base Station Duplexer	144-174 MHz	5"	4	600 KHz	\$820.18
TPRD-1556	Pass-Reject Base Station Duplexer	144-174 MHz	5"	6	400 KHz	\$1,327.57
TPRD-1584	Pass-Reject Base Station Duplexer	148-174 MHz	8"	4	500 KHz	\$1,198.11
TPRD-1586	Pass-Reject Base Station Duplexer	148-174 MHz	8"	6	300 KHz	\$1,797.16
TPCD-1553	Band-Pass Base Station Duplexer	148-174 MHz	5"	3	5 MHz	\$622.37
TPCD-1554	Band-Pass Base Station Duplexer	148-174 MHz	5"	4	4 MHz	\$820.18
TPCD-1556	Band-Pass Base Station Duplexer	148-174 MHz	5"	6	2 MHz	\$1,239.92
TPRD-2254	Pass-Reject Base Station Duplexer	200-300 MHz	5"	4	1.2 MHz	\$820.18
TPRD-2284	Pass-Reject Base Station Duplexer	200-300 MHz	8"	4	1 MHz	\$1,198.11
TPRD-22612	Pass-Reject Base Station Duplexer	200-300 MHz	6"	12	400 KHz	\$3,974.67
TPRD-3544	Pass-Reject Base Station Duplexer	300-400 MHz	4"	4	5 MHz	\$1,099.20
TPRD-3546	Pass-Reject Base Station Duplexer	300-400 MHz	4"	6	5 MHz	\$1,421.65

SECTION 6**DUPLEXERS****BASE STATION DUPLEXERS 370-1300 MHz**

MODEL	DESCRIPTION	FREQ. RANGE	CAVITIES DIA. NO.		MINIMUM SPACING	GSA PRICE
TPRD-3844	Pass-Reject Base Station Duplexer	370-430 MHz	4"	4	5 MHz	\$1,099.20
TPRD-3846	Pass-Reject Base Station Duplexer	370-430 MHz	4"	6	5 MHz	\$1,421.65
TPRD-4544	Pass-Reject Base Station Duplexer	400-512 MHz	4"	4	5 MHz	\$864.41
TPRD-4744	Pass-Reject Base Station Duplexer	470-512 MHz	4"	4	3 MHz	\$864.41
TPRD-4546	Pass-Reject Base Station Duplexer	400-512 MHz	4"	6	3 MHz	\$1,606.59
TPCD-4554	Band-Pass Base Station Duplexer	400-512 MHz	5"	4	5 MHz	\$714.04
TPCD-4556	Band-Pass Base Station Duplexer	400-512 MHz	5"	6	5 MHz	\$1,093.58
TPRD-7644	Pass-Reject Base Station Duplexer	763-869 MHz	4"	4	30 or 45 MHz	\$1,208.34
TTPD-7642	Pass-Reject Base Station Duplexer	763-869 MHz	4"	2	30 or 45 MHz	\$648.40
TTPD-7644	5 MHz Bandpass-Bandreject Duplexer	763-869 MHz	4"	4	30 or 45 MHz	\$1,208.34
TPRD-8642	Pass-Reject Base Station Duplexer	806-960 MHz	4"	2	5 MHz	\$619.96
TPRD-8644	Pass-Reject Base Station Duplexer	763-869 MHz	4"	4	30 or 45 MHz	\$1,208.34
TTPD-8642	Pass-Reject Base Station Duplexer	806-960 MHz	4"	2	45 MHz	\$467.99
TTPD-8644	5 MHz Bandpass-Bandreject Duplexer	806-960 MHz	4"	4	45 MHz	\$998.69
TPCD-8626	Band-Pass Comblin Duplexer	806-960 MHz	2"	6	45 MHz	\$998.69
TPCD-8626HP	500 Watt Comblin Duplexer	806-960 MHz	2"	6	45 MHz	\$1,357.32
TPCD-8926	Band-Pass Comblin Cellular Duplexer	824-845 MHz	2"	6	45 MHz	\$970.93
TPCD-8926B	Band-Pass Comblin Cellular Duplexer	824-835 MHz	2"	6	45 MHz	\$970.93
TPCD-8928	Band-Pass Comblin Cellular Duplexer	824-849 MHz	2"	8	45 MHz	\$1,188.43
TPRD-9044	Pass-Reject Base Station Duplexer NSN: 5895014939369	890-960 MHz	4"	4	39, 3.6 MHz	\$998.69
TPRD-12044	Pass-Reject Base Station Duplexer	1200-1300 MHz	4"	4	6, 12 MHz	\$870.04

COMPACT MOBILE DUPLEXERS - 70-960 MHz

Specify N-Female or BNC Female connectors.

MODEL	DESCRIPTION	FREQ. RANGE	CAVITIES DIA. NO.		TX-RX SEP.	GSA PRICE
TMND-0716	Compact Mobile Notch Duplexer	70-78 MHz	1"	6	4 MHz	\$324.05
TMND-0816	Compact Mobile Notch Duplexer	77-85 MHz	1"	6	4 MHz	\$324.05
TMND-1516	Compact Mobile Notch Duplexer	148-157 MHz	1"	6	4 MHz	\$291.08
TMND-1616	Compact Mobile Notch Duplexer	156-165 MHz	1"	6	4 MHz	\$291.08
TMND-1716	Compact Mobile Notch Duplexer	164-174 MHz	1"	6	4 MHz	\$291.08
TMND-4416	Compact Mobile Notch Duplexer	440-450 MHz	1"	6	5 MHz	\$337.72
TMND-4516	Compact Mobile Notch Duplexer	450-460 MHz	1"	6	5 MHz	\$279.02
TMND-4616	Compact Mobile Notch Duplexer	460-470 MHz	1"	6	5 MHz	\$279.02
TMND-4716	Compact Mobile Notch Duplexer	470-480 MHz	1"	6	5 MHz	\$279.02
TMND-4816	Compact Mobile Notch Duplexer	480-490 MHz	1"	6	5 MHz	\$279.02
TMND-4916	Compact Mobile Notch Duplexer	490-500 MHz	1"	6	5 MHz	\$279.02
TMND-5016	Compact Mobile Notch Duplexer	500-512 MHz	1"	6	5 MHz	\$279.02
TMND-8616	Compact Mobile Notch Duplexer	806-869 MHz	1"	6	45 MHz	\$279.02
TMND-9216	Compact Mobile Notch Duplexer	928-960 MHz	1"	6	24 MHz	\$279.02

ANTENNA MODEL NUMBER NOMENCLATURE

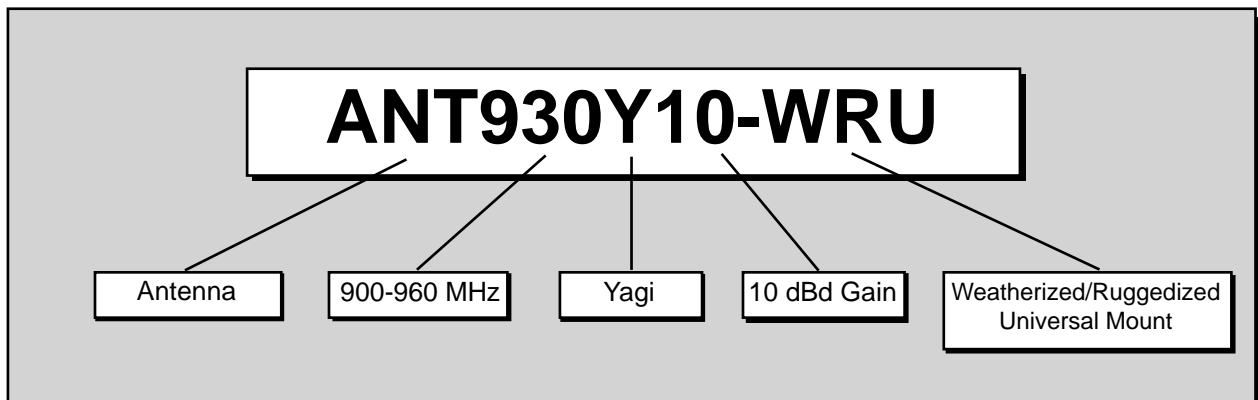
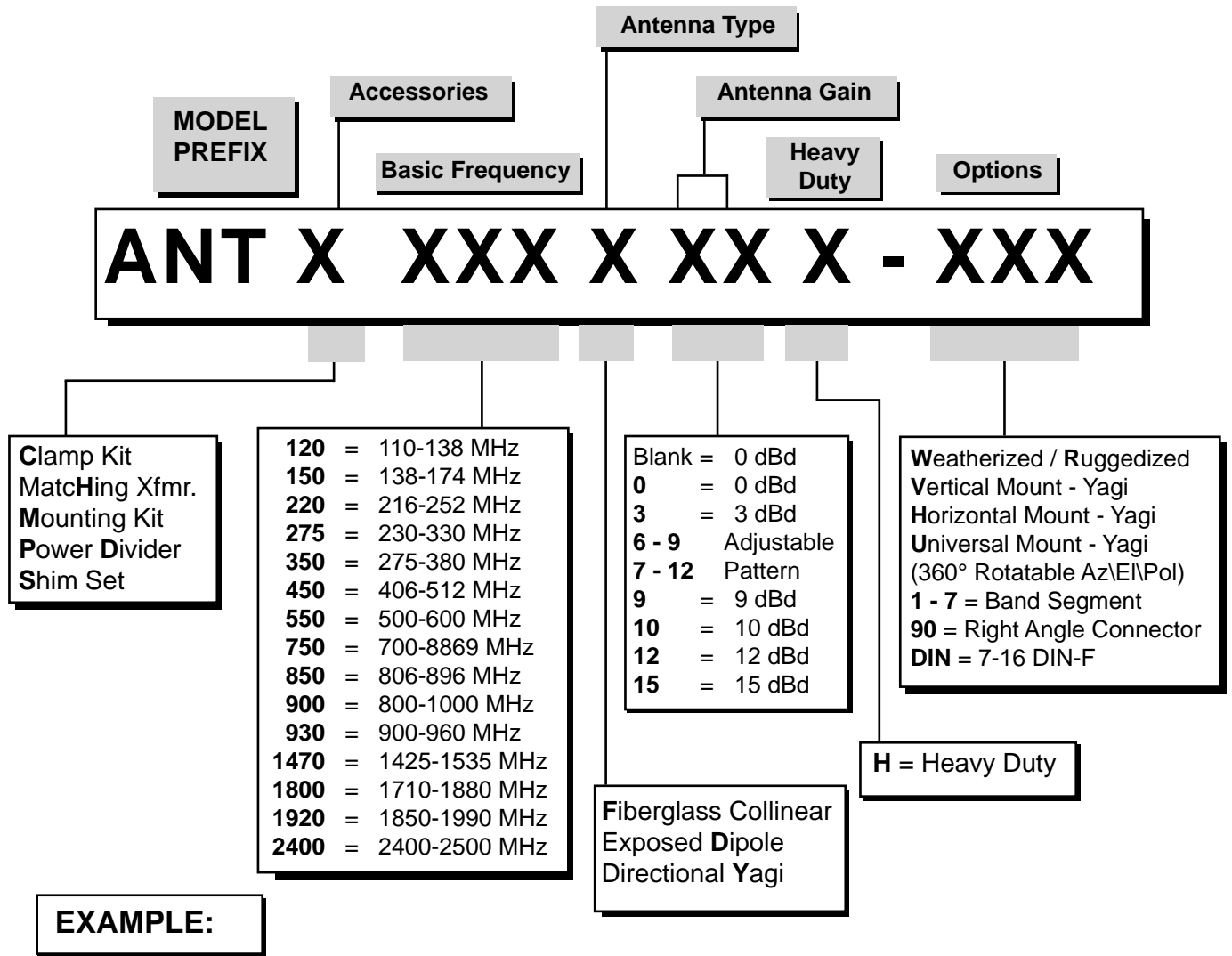

SECTION 7**ANTENNAS****BASE STATION ANTENNAS - 118-960 MHz****FIBERGLASS COLLINEAR 500 WATTS OMNI PATTERNS**

Standard connector is a recessed N-Female. 7-16 DIN* available. Inverted mounting: specify "-INV".

Each antenna includes mounting clamps and a 24" N-Male to N-Male pigtail (except ANT960F0).

MODEL	FREQ. RANGE	GAIN	INSTALLED HEIGHT	SHIP WEIGHT	UPS	GSA PRICE
ANT125F2	118-136 MHz	2.5 dBd	77"	20 lb	Y	\$521.86
ANT135F2	125-150 MHz	2.5 dBd	72"	18 lb	Y	\$521.86
ANT140F2	135-165 MHz	2.5 dBd	66"	17 lb	Y	\$513.02
ANT150F2	148-174 MHz	2.5 dBd	60"	16 lb	Y	\$509.00
ANT150F6-1	138-144 MHz	6 dBd	256"	55 lb	N	\$632.02
ANT150F6-2	144-151 MHz	6 dBd	256"	55 lb	N	\$632.02
ANT150F6-3	150-157 MHz	6 dBd	244"	50 lb	N	\$632.02
ANT150F6-4	156-164 MHz	6 dBd	244"	50 lb	N	\$632.02
ANT150F6-5	158-166 MHz	6 dBd	244"	50 lb	N	\$632.02
ANT150F6-6	161-168 MHz	6 dBd	244"	50 lb	N	\$632.02
ANT150F6-7	167-174 MHz	6 dBd	244"	50 lb	N	\$632.02
ANT220F2	195-260 MHz	2.5 dBd	48"	14 lb	Y	\$491.31
ANT220F6	216-225 MHz	6 dBd	171"	40 lb	N	\$651.32
ANT355F6	340-370 MHz	6 dBd	126"	30 lb	N	\$632.02
ANT385F6	370-401 MHz	6 dBd	115"	35 lb	N	\$632.02
ANT400F2	360-455 MHz	2.5 dBd	46"	14 lb	Y	\$398.40
ANT415F6	405-440 MHz	6 dBd	101"	25 lb	Y	\$576.54
ANT415F8	395-436 MHz	8 dBd	240"	55 lb	N	\$996.28
ANT440F6	440-465 MHz	6 dBd	94"	26 lb	Y	\$670.33
ANT450F2	420-480 MHz	2.5 dBd	43"	14 lb	Y	\$398.03
ANT450F6	445-480 MHz	6 dBd	94"	24 lb	Y	\$521.06
ANT450F10	430-475 MHz	10 dBd	244"	50 lb	N	\$806.51
ANT480F2	450-512 MHz	2.5 dBd	39"	14 lb	Y	\$398.03
ANT500F6	470-512 MHz	6 dBd	89"	14 lb	Y	\$689.92
ANT500F10	470-512 MHz	10 dBd	244"	50 lb	N	\$975.15
ANT770F2	734-806 MHz	2.5 dBd	38"	9 lb	Y	\$376.32
ANT734-960F2	734-960 MHz	2.5 dBd	38"	9 lb	Y	\$413.02
ANT770F6	746-806 MHz	6 dBd	56"	11 lb	Y	\$692.26
ANT790F2	763-869 MHz	2.5 dBd	38"	9 lb	Y	\$413.02
ANT850F2	806-896 MHz	2.5 dBd	38"	6 lb	Y	\$376.32
ANT850F6	806-896 MHz	6 dBd	56"	11 lb	Y	\$692.26
ANT850F10	806-896 MHz	10 dBd	88"	40 lb	Y	\$1,001.10
ANT900F2	880-960 MHz	2.5 dBd	38"	6 lb	Y	\$376.32
ANT940F6	870-965 MHz	6 dBd	56"	8 lb	Y	\$692.26
ANT940F10	870-965 MHz	10 dBd	82"	12 lb	Y	\$1,001.10
ANT960F0-1	900-930 MHz	2 dBd	15"	2 lb	Y	\$48.25
ANT960F0-2	920-960 MHz	2 dBd	15"	2 lb	Y	\$48.25

Y = UPS shippable
N = Not UPS shippable

SECTION 7**ANTENNAS****BASE STATION ANTENNAS - 33-405 MHz****DIPOLES AND DIPOLE ARRAYS 500 WATTS ADJUSTABLE PATTERNS**

Standard connector is N-Male on a pigtail. 7-16 DIN available. All dipoles and arrays are field-configurable and UPS shippable (except 37D, 40D, 50D), and include clamps for mounting to an existing mast or other support. 2, 4, and 8 bay arrays can be ordered with up to 15 degrees of electrical uptilt or downtilt.

MODEL	FREQ. RANGE	BAYS	GAIN	INSTALLED HEIGHT	SHIP WEIGHT	GSA PRICE
ANT37D	33.5-41 MHz	1	1 to 2.6 dBd	145"	80 lb	\$1,443.36
ANT40D	37-45 MHz	1	1 to 2.6 dBd	129"	74 lb	\$1,387.07
ANT50D	45-54 MHz	1	1 to 2.6 dBd	108"	69 lb	\$1,387.07
ANT70D	63-78 MHz	1	1 to 2.6 dBd	76"	36 lb	\$586.99
ANT75D	66-88 MHz	1	1 to 2.6 dBd	68"	30 lb	\$586.99
ANT90D	88-108 MHz	1	1 to 2.6 dBd	56"	27 lb	\$562.87
ANT120D	110-138 MHz	1	1 to 2.6 dBd	45"	9 lb	\$261.33
ANT150D	138-174 MHz	1	1 to 2.6 dBd	34"	8 lb	\$201.83
ANT150D3	138-174 MHz	2	3 to 6 dBd	91"	21 lb	\$410.09
ANT150D6-9	138-174 MHz	4	6 to 9 dBd	205"	34 lb	\$701.18
ANT150D7-12	138-174 MHz	8	7 to 12 dBd	433"	68 lb	\$1,695.85
ANT220D	216-252 MHz	1	1 to 2.6 dBd	23"	8 lb	\$214.69
ANT220D3	216-252 MHz	2	3 to 6 dBd	61"	20 lb	\$365.06
ANT220D6-9	216-252 MHz	4	6 to 9 dBd	137"	32 lb	\$720.47
ANT220D7-12	216-252 MHz	8	7 to 12 dBd	300"	64 lb	\$1,742.48
ANT275D	230-330 MHz	1	1 to 2.6 dBd	19"	8 lb	\$267.55
ANT275D3	230-330 MHz	2	3 to 6 dBd	51"	18 lb	\$449.49
ANT275D6-9	230-330 MHz	4	6 to 9 dBd	115"	30 lb	\$857.97
ANT275D7-12	230-330 MHz	8	7 to 12 dBd	220"	60 lb	\$1,715.66
ANT350D	300-360 MHz	1	1 to 2.6 dBd	17"	7 lb	\$208.46
ANT350D3	300-360 MHz	2	3 to 6 dBd	44"	16 lb	\$365.06
ANT350D6-9	300-360 MHz	4	6 to 9 dBd	98"	27 lb	\$628.81
ANT350D7-12	300-360 MHz	8	7 to 12 dBd	178"	54 lb	\$1,522.67
ANT375D	345-405 MHz	1	1 to 2.6 dBd	15"	7 lb	\$192.98
ANT375D3	345-405 MHz	2	3 to 6 dBd	39"	15 lb	\$454.32
ANT375D6-9	345-405 MHz	4	6 to 9 dBd	87"	25 lb	\$760.68
ANT375D7-12	345-405 MHz	8	7 to 12 dBd	161"	50 lb	\$1,522.67

SECTION 7

ANTENNAS

BASE STATION ANTENNAS - 360-1000 MHz

DIPOLES AND DIPOLE ARRAYS 500 WATTS ADJUSTABLE PATTERNS

Standard connector is N-Male on a pigtail. 7-16 DIN* available. All dipoles and arrays are field-configurable and UPS shippable, and include clamps for mounting to an existing mast or other support. 2, 4, and 8 bay arrays can be ordered with up to 15 degrees of electrical uptilt or downtilt.

MODEL	FREQ. RANGE	BAYS	GAIN	INSTALLED HEIGHT	SHIP WEIGHT	GSA PRICE
ANT400D	360-450 MHz	1	1 to 2.6 dBd	14"	7 lb	\$159.21
ANT400D3	360-450 MHz	2	3 to 6 dBd	36"	15 lb	\$375.51
ANT400D6-9	360-450 MHz	4	6 to 9 dBd	80"	24 lb	\$628.81
ANT400D7-12	360-450 MHz	8	7 to 12 dBd	168"	48 lb	\$1,522.67
ANT450D	406-512 MHz	1	1 to 2.6 dBd	12"	6 lb	\$159.21
ANT450D3	406-512 MHz	2	3 to 6 dBd	31"	19 lb	\$375.51
ANT450D6-9	406-512 MHz	4	6 to 9 dBd	69"	21 lb	\$628.81
ANT450D7-12	406-512 MHz	8	7 to 12 dBd	145"	42 lb	\$1,522.67
ANT500D	470-550 MHz	1	1 to 2.6 dBd	11"	5 lb	\$192.98
ANT500D3	470-550 MHz	2	3 to 6 dBd	28"	18 lb	\$454.32
ANT500D6-9	470-550 MHz	4	6 to 9 dBd	62"	22 lb	\$760.68
ANT500D7-12	470-550 MHz	8	7 to 12 dBd	180"	44 lb	\$1,522.67
ANT550D	500-600 MHz	1	1 to 2.6 dBd	10"	5 lb	\$159.21
ANT550D3	500-600 MHz	2	3 to 6 dBd	26"	16 lb	\$375.51
ANT550D6-9	500-600 MHz	4	6 to 9 dBd	58"	22 lb	\$628.81
ANT550D7-12	500-600 MHz	8	7 to 12 dBd	174"	44 lb	\$1,522.67
ANT750D	700-825 MHz	1	1 to 2.6 dBd	8"	3 lb	\$203.95
ANT750D3	700-825 MHz	2	3 to 6 dBd	19"	6 lb	\$459.14
ANT750D6-9	700-825 MHz	4	6 to 9 dBd	42"	12 lb	\$768.72
ANT750D7-12	700-825 MHz	8	7 to 12 dBd	91"	22 lb	\$1,633.05
ANT900D	800-1000 MHz	1	1 to 2.6 dBd	7"	5 lb	\$214.69
ANT900D3	800-1000 MHz	2	3 to 6 dBd	17"	10 lb	\$465.57
ANT900D6-9	800-1000 MHz	4	6 to 9 dBd	37"	20 lb	\$792.04
ANT900D7-12	800-1000 MHz	8	7 to 12 dBd	86"	40 lb	\$1,584.08

NOTE: ANT 900Dx supplied with N-Female on power divider.
DIN-F optional.

SECTION 7**ANTENNAS****BASE STATION ANTENNAS - 138-2500 MHz****DIRECTIONAL YAGI 500 WATTS**

WR Yagi antennas have a welded vertical mounting plate. WRH = Horizontal plate, WRU = Universal Mount option.

WRDIN = 7-16 DIN. All models are UPS shippable. Standard connector N-Female.

MODEL	FREQ. RANGE	GAIN	LENGTH	SHIP WEIGHT	GSA PRICE
ANT144Y5-WR	138-152 MHz	5 dBd	38"	22 lb	\$438.23
ANT144Y5-WRH	138-152 MHz	5 dBd	38"	22 lb	\$438.23
ANT150Y7-WR	148-174 MHz	5 dBd	38"	21 lb	\$348.98
ANT150Y7-WRH	148-174 MHz	5 dBd	38"	21 lb	\$338.95
ANT150Y7-WRDIN	148-174 MHz	5 dBd	38"	21 lb	\$371.62
ANT150Y10H	144-174 MHz	5 dBd	96"	37 lb	\$852.35
ANT220Y7-WR	216-240 MHz	5 dBd	30"	16 lb	\$246.22
ANT220Y7-WRH	216-240 MHz	5 dBd	30"	16 lb	\$246.22
ANT220Y7-WRDIN	216-240 MHz	5 dBd	30"	16 lb	\$278.89
ANT410Y10-WR	405-420 MHz	10 dBd	44"	11 lb	\$224.06
ANT410Y10-WRH	405-420 MHz	10 dBd	44"	11 lb	\$224.06
ANT410Y10-WRDIN	405-420 MHz	10 dBd	44"	11 lb	\$256.73
ANT410Y10-WRU	405-420 MHz	10 dBd	44"	13 lb	\$259.15
ANT420Y10-WR	415-450 MHz	10 dBd	44"	11 lb	\$279.83
ANT420Y10-WRH	415-450 MHz	10 dBd	44"	11 lb	\$279.83
ANT420Y10-WRU	415-450 MHz	10 dBd	44"	13 lb	\$324.05
ANT430Y10-WR	420-440 MHz	10 dBd	44"	11 lb	\$224.06
ANT430Y10-WRH	420-440 MHz	10 dBd	44"	11 lb	\$224.06
ANT430Y10-WRDIN	420-440 MHz	10 dBd	44"	11 lb	\$224.06
ANT430Y10-WRU	420-440 MHz	10 dBd	44"	13 lb	\$259.15
ANT440Y10-WR	438-455 MHz	10 dBd	44"	11 lb	\$224.06
ANT440Y10-WRH	438-455 MHz	10 dBd	44"	11 lb	\$224.05
ANT440Y10-WRDIN	438-455 MHz	10 dBd	44"	11 lb	\$256.73
ANT440Y10-WRU	438-455 MHz	10 dBd	44"	13 lb	\$259.15
ANT450Y5-WR	450-470 MHz	5 dBd	24"	9 lb	\$214.69
ANT450Y5-WRH	450-470 MHz	5 dBd	24"	9 lb	\$214.69
ANT450Y5-WRU	450-470 MHz	5 dBd	24"	11 lb	\$258.92
ANT450Y7-WR	450-470 MHz	7 dBd	29"	9 lb	\$197.80
ANT450Y7-WRH	450-470 MHz	7 dBd	29"	9 lb	\$240.43
ANT450Y7-WRU	450-470 MHz	7 dBd	29"	11 lb	\$284.65
ANT450Y10-WR	450-470 MHz	10 dBd	44"	11 lb	\$224.05
ANT450Y10-WRH	450-470 MHz	10 dBd	44"	11 lb	\$224.05
ANT450Y10-WRDIN	450-470 MHz	10 dBd	44"	11 lb	\$256.73
ANT450Y10-WRU	450-470 MHz	10 dBd	44"	13 lb	\$259.15
ANT490Y10-WR	470-500 MHz	10 dBd	44"	11 lb	\$224.05
ANT490Y10-WRH	470-500 MHz	10 dBd	44"	11 lb	\$224.05
ANT490Y10-WRDIN	470-500 MHz	10 dBd	44"	11 lb	\$256.73
ANT490Y10-WRU	470-500 MHz	10 dBd	44"	13 lb	\$259.15

SECTION 7**ANTENNAS****BASE STATION ANTENNAS - 500-2500 MHz****DIRECTIONAL YAGI 500 WATTS**

WR Yagi antennas ship standard with a vertical mounting plate. **WRH** = Horizontal plate, **WRU** = Universal.
All models are UPS shippable. Standard connector N-Female. 7-16 DIN available (add \$51.00).

MODEL	FREQ. RANGE	GAIN	LENGTH	SHIP WEIGHT	GSA PRICE
ANT500Y10-WR	485-512 MHz	10 dBd	44"	11 lb	\$224.05
ANT500Y10-WRH	485-512 MHz	10 dBd	44"	11 lb	\$224.05
ANT500Y10-WRDIN	485-512 MHz	10 dBd	44"	11 lb	\$224.05
ANT500Y10-WRU	485-512 MHz	10 dBd	44"	13 lb	\$259.15
ANT750Y5-WR	734-806 MHz	5 dBd	13"	3 lb	\$281.44
ANT750Y5-WRH	734-806 MHz	5 dBd	13"	3 lb	\$281.44
ANT750Y5-WRU	734-806 MHz	5 dBd	13"	3 lb	\$308.77
ANT830Y10-WR	800-870 MHz	10 dBd	24"	3 lb	\$167.43
ANT830Y10-WRH	800-870 MHz	10 dBd	24"	3 lb	\$167.43
ANT830Y10-WRDIN	800-870 MHz	10 dBd	24"	3 lb	\$201.31
ANT830Y10-WRU	800-870 MHz	10 dBd	24"	3 lb	\$190.30
ANT850Y10-WR	822-900 MHz	10 dBd	24"	3 lb	\$167.43
ANT850Y10-WRH	822-900 MHz	10 dBd	24"	3 lb	\$167.43
ANT850Y10-WRDIN	822-900 MHz	10 dBd	24"	3 lb	\$201.31
ANT850Y10-WRU	822-900 MHz	10 dBd	24"	3 lb	\$190.30
ANT930Y10-WR	885-975 MHz	10 dBd	28"	3 lb	\$187.87
ANT930Y10-WRH	885-975 MHz	10 dBd	28"	3 lb	\$187.87
ANT930Y10-WRDIN	885-975 MHz	10 dBd	28"	3 lb	\$249.27
ANT930Y10-WRU	885-975 MHz	10 dBd	28"	3 lb	\$244.15
ANT930Y12-WR	880-960 MHz	12 dBd	44"	18 lb	\$505.78
ANT930Y12-WRH	880-960 MHz	12 dBd	44"	18 lb	\$505.78
ANT930Y12-WRU	880-960 MHz	12 dBd	44"	18 lb	\$511.70
ANT940Y10-WR	900-960 MHz	10 dBd	23"	3 lb	\$178.36
ANT940Y10-WRH	900-960 MHz	10 dBd	23"	3 lb	\$178.36
ANT940Y10-WRDIN	900-960 MHz	10 dBd	23"	3 lb	\$212.81
ANT940Y10-WRU	900-960 MHz	10 dBd	23"	3 lb	\$201.80
ANT1470Y12-WR*	1425-1535 MHz	12 dBd	26.5"	6 lb	\$155.94
ANT1470Y12-WRDIN*	1425-1535 MHz	12 dBd	26.5"	6 lb	\$189.82
ANT1470Y12-WRU	1425-1535 MHz	12 dBd	26.5"	6 lb	\$192.36
ANT1800Y10-WR*	1710-1880 MHz	10 dBd	19"	6 lb	\$145.28
ANT1800Y10-WRDIN*	1710-1880 MHz	10 dBd	19"	6 lb	\$179.15
ANT1800Y10-WRU	1710-1880 MHz	10 dBd	19"	6 lb	\$168.15
ANT1920Y9-WR*	1850-1990 MHz	9.3 dBd	10"	5 lb	\$135.42
ANT1920Y9-WRDIN	1850-1990 MHz	9.3 dBd	10"	5 lb	\$169.30
ANT1920Y9-WRU	1850-1990 MHz	9.3 dBd	10"	5 lb	\$171.84
ANT1920Y12-WR*	1850-1990 MHz	12 dBd	23"	6 lb	\$145.28
ANT1920Y12-WRDIN*	1850-1990 MHz	12 dBd	23"	6 lb	\$179.15
ANT1920Y12-WRU	1850-1990 MHz	12 dBd	23"	6 lb	\$181.70
ANT2045Y12-WR*	1920-2170 MHz	12 dBd	23"	6 lb	\$248.47
ANT2045Y12-WRU	1920-2170 MHz	12 dBd	23"	6 lb	\$275.81
ANT2400Y12-WR*	2400-2500 MHz	12 dBd	16"	6 lb	\$145.28
ANT2400Y12-WRDIN*	2400-2500 MHz	12 dBd	16"	6 lb	\$145.28
ANT2400Y12-WRU	2400-2500 MHz	12 dBd	16"	6 lb	\$145.28

* Antennas from 1470-2500 MHz are shipped with a U-clamp which allows variable V or H polarization.

SECTION 7**ANTENNAS****WIDEBAND ANTENNAS**

MODEL	FREQ. RANGE	GAIN	DESCRIPTION	SHIP WEIGHT	GSA PRICE
ANT26BL	26-550 MHz	0-5 dBd dep. on freq.	"Bowlog" wideband directional	130 lb	\$7,860.08
ANT500L	500 MHz - 2.0 GHz	4-7 dBi dep. on freq.	Compact wideband directional	12 lb	\$1,034.68
ANT260K	118-400 MHz	0 dBd	Wideband discone	102 lb	\$5,367.37
ANT300K	225-400 MHz	0 dBd	Wideband discone	82 lb	\$5,011.15
ANT400K	400 MHz - 3.0 GHz	1 dBi	Wideband discone	45 lb	\$2,295.71

ANTENNA MOUNTING HARDWARE

MODEL	DESCRIPTION	SHIP WEIGHT	UPS	GSA PRICE
ANTM010	10 foot 1.5" dia. Schd. 40 Galvanized Steel mast (1.9" O.D.)	28 lb	Y	\$67.25
ANTM020	21 foot 2" dia. Schd. 40 Galvanized Steel mast (2.375" O.D.)	77 lb	N	\$151.32
ANTS420	Mast clamps shim set (2) for Dipoles on small tower legs	1 lb	Y	\$11.26
ANTM431	Mast top support bracket for Dipoles	9 lb	Y	\$103.73
ANTM432	Insulated antenna top support for Collinears	4 lb	Y	\$103.73
ANTM433	Antenna side mount kit for Collinear or Dipole	12 lb	Y	\$135.89
ANTM434	Adjustable side mount stand-off clamp kit	57 lb	Y	\$406.87
ANTM434-M	Adjustable stand-off side mount kit with support booms	97 lb	N	\$742.18
ANTM435	Single side mount assembly	29 lb	Y	\$204.24
ANTC482	Dual Mounting clamp for Collinears - Center clamps not welded	12 lb	Y	\$107.46
ANTC483	Dual Mounting clamp kit for Fiberglass Collinear antennas	12 lb	Y	\$89.26
ANTC483SS	ANTC483 Clamp Kit - Stainless Steel	12 lb	Y	\$340.65
ANTC484	Single mounting clamp for side mount antennas	5 lb	Y	\$28.95
ANTC485	Dual U-bolt clamp set for F2 Collinear antennas	3 lb	Y	\$40.94
ANTM400H	Horizontal mount for 150, 220 & 400Y10-WR Yagi antennas	2 lb	Y	\$33.77
ANTM940H	Horizontal mount for 800 & 900Y10-WR Yagi antennas	2 lb	Y	\$28.14

Y = UPS shippable
N = Not UPS shippable

SECTION 7**POWER DIVIDERS****POWER DIVIDERS 24-2500 MHZ 500 WATTS N-FEMALE and 7-16 DIN**

Frequency range shown is 1.5:1 VSWR bandwidth. Typical response is <1.2:1 at band center.

All power dividers are UPS shippable. 5-way and 6-way dividers are available as a special order.

DESCRIPTION	N FEMALE	SHIP WT	GSA PRICE	7-16 DIN	SHIP WT	GSA PRICE
2-Way Power Divider 24-54 MHz	ANTPD204	10 lb.	\$165.64	ANTPD204D	11 lb.	\$205.85
2-Way Power Divider 45-72 MHz	ANTPD206	7 lb.	\$165.64	ANTPD206D	8 lb.	\$205.85
2-Way Power Divider 65-110 MHz	ANTPD208	7 lb.	\$103.73	ANTPD208D	7.5 lb.	\$190.06
3-Way Power Divider 65-110 MHz	ANTPD308	7 lb.	\$145.54	ANTPD308D	7.5 lb.	\$230.27
4-Way Power Divider 65-110 MHz	ANTPD408	7 lb.	\$158.41	ANTPD408D	7.5 lb.	\$258.04
2-Way Power Divider 90-210 MHz	ANTPD21	4.5 lb.	\$90.06	ANTPD21D	5 lb.	\$147.66
3-Way Power Divider 90-210 MHz	ANTPD31	4.5 lb.	\$127.05	ANTPD31D	5 lb.	\$206.14
4-Way Power Divider 90-210 MHz	ANTPD41	4.5 lb.	\$135.09	ANTPD41D	5 lb.	\$227.34
2-Way Power Divider 180-250 MHz	ANTPD22	3.5 lb.	\$90.06	ANTPD22D	4 lb.	\$147.66
3-Way Power Divider 180-250 MHz	ANTPD32	3.5 lb.	\$127.05	ANTPD32D	4 lb.	\$206.14
4-Way Power Divider 180-250 MHz	ANTPD42	3.5 lb.	\$135.09	ANTPD42D	4 lb.	\$227.34
2-Way Power Divider 250-450 MHz	ANTPD23	3 lb.	\$90.06	ANTPD23D	3.5 lb.	\$147.66
3-Way Power Divider 250-450 MHz	ANTPD33	3 lb.	\$127.05	ANTPD33D	3.5 lb.	\$206.14
4-Way Power Divider 250-450 MHz	ANTPD43	3 lb.	\$135.09	ANTPD43D	3.5 lb.	\$227.34
2-Way Power Divider 350-600 MHz	ANTPD24	2 lb.	\$82.02	ANTPD24D	3 lb.	\$138.16
3-Way Power Divider 350-600 MHz	ANTPD34	2 lb.	\$122.22	ANTPD34D	3 lb.	\$201.03
4-Way Power Divider 350-600 MHz	ANTPD44	2 lb.	\$131.87	ANTPD44D	3 lb.	\$223.69
2-Way Power Divider 675-850 MHz	ANTPD27	1.5 lb.	\$98.69	ANTPD27D	2.5 lb.	\$138.16
3-Way Power Divider 675-850 MHz	ANTPD37	1.5 lb.	\$147.66	ANTPD37D	2.5 lb.	\$201.03
4-Way Power Divider 675-850 MHz	ANTPD47	1.5 lb.	\$159.21	ANTPD47D	2.5 lb.	\$223.54
2-Way Power Divider 760-920 MHz	ANTPD28	1.5 lb.	\$82.02	ANTPD28D	2.5 lb.	\$138.16
3-Way Power Divider 760-920 MHz	ANTPD38	1.5 lb.	\$122.22	ANTPD38D	2.5 lb.	\$201.03
4-Way Power Divider 760-920 MHz	ANTPD48	1.5 lb.	\$131.87	ANTPD48D	2.5 lb.	\$223.69
2-Way Power Divider 900-1100 MHz	ANTPD29	1.5 lb.	\$82.02	ANTPD29D	2.5 lb.	\$138.16
3-Way Power Divider 900-1100 MHz	ANTPD39	1.5 lb.	\$122.22	ANTPD39D	2.5 lb.	\$201.03
4-Way Power Divider 900-1100 MHz	ANTPD49	1.5 lb.	\$131.87	ANTPD49D	2.5 lb.	\$223.69
2-Way Power Divider 1350-1600 MHz	ANTPD214	1 lb.	\$82.02	ANTPD214D	2 lb.	\$138.16
3-Way Power Divider 1350-1600 MHz	ANTPD314	1 lb.	\$122.22	ANTPD314D	2 lb.	\$201.03
4-Way Power Divider 1350-1600 MHz	ANTPD414	1 lb.	\$131.87	ANTPD414D	2 lb.	\$223.69
2-Way Power Divider 1700-2050 MHz	ANTPD218	1 lb.	\$82.02	ANTPD218D	2 lb.	\$138.16
3-Way Power Divider 1700-2050 MHz	ANTPD318	1 lb.	\$122.22	ANTPD318D	2 lb.	\$201.03
4-Way Power Divider 1700-2050 MHz	ANTPD418	1 lb.	\$131.87	ANTPD418D	2 lb.	\$223.69
2-Way Power Divider 2000-2500 MHz	ANTPD224	1 lb.	\$82.02	ANTPD224D	2 lb.	\$138.16
3-Way Power Divider 2000-2500 MHz	ANTPD324	1 lb.	\$122.22	ANTPD324D	2 lb.	\$201.03
4-Way Power Divider 2000-2500 MHz	ANTPD424	1 lb.	\$131.87	ANTPD424D	2 lb.	\$223.69

SECTION 7

COUPLERS / JUNCTIONS / EZ-MATCH

CROSSBAND COUPLERS

Standard connectors are N-Female. DIN-F optional.

MODEL	DESCRIPTION	FREQ. RANGE	TX POWER	GSA PRICE
TS-1545	Crossband Coupler	132-174 & 406-470 MHz	150 Watts	\$248.47
TS-1545H	Crossband Coupler	132-174 & 406-470 MHz	400 Watts	\$303.15
TS-1546	Crossband Coupler	132-174 & 450-512 MHz	150 Watts	\$248.47
TS-1546H	Crossband Coupler	132-174 & 450-512 MHz	400 Watts	\$303.15
TS-1570	Crossband Coupler	132-174 & 763-869 MHz	150 Watts	\$248.54
TS-1570H	Crossband Coupler	132-174 & 763-869 MHz	400 Watts	\$303.37
TS-1580	Crossband Coupler	132-174 & 806-902 MHz	150 Watts	\$225.95
TS-1580H	Crossband Coupler	132-174 & 806-902 MHz	400 Watts	\$303.15
TS-1590	Crossband Coupler	132-174 & 850-960 MHz	150 Watts	\$248.47
TS-1590H	Crossband Coupler	132-174 & 850-960 MHz	400 Watts	\$303.15
TS-2246	Crossband Coupler	219-225 & 406-512 MHz	150 Watts	\$248.47
TS-2246H	Crossband Coupler	219-225 & 406-512 MHz	400 Watts	\$303.15
TS-4670	Crossband Coupler	440-470 & 763-869 MHz	400 Watts	\$248.54
TS-4680	Crossband Coupler	440-470 & 806-870 MHz	400 Watts	\$225.95
TS-4690	Crossband Coupler	440-470 & 896-932 MHz	400 Watts	\$248.47
TS-4770	Crossband Coupler	470-512 & 763-869 MHz	400 Watts	\$248.54
TS-4780	Crossband Coupler	470-512 & 896-932 MHz	400 Watts	\$248.47
TS-154676	Triband / Crossband Coupler	150-174 / 450-470 / 763-869 MHz	400 Watts	Contact Fact.

COMBINER JUNCTIONS

Standard connectors are N-Female. DIN-F optional.

MODEL	DESCRIPTION	FREQ. RANGE	TX POWER	GSA PRICE
TW4-50	4-Way Junction	30-54 MHz	400 Watts	\$167.43
TW4-150	4-Way Junction	70-250 MHz	400 Watts	\$167.43
TW6-150	6-Way Junction	70-250 MHz	400 Watts	\$189.58
TW4-450	4-Way Junction	450-512 MHz	400 Watts	\$167.43
TW6-450	6-Way Junction	450-512 MHz	400 Watts	\$189.58
TW4-800	4-Way Junction	806-960 MHz	400 Watts	\$167.43
TW4-800S	4-Way Junction with sampling port	806-960 MHz	400 Watts	\$198.60
TW5-800	5-Way Junction	806-960 MHz	400 Watts	\$198.60
TRS-890	RF Sample Port, BNC output, -30 to -60 dB. Must specify freq. and coupling factor.			\$73.04
TRS-890-20	RF Sample Port, BNC output, -20 dB. Must specify freq.			\$134.28
TW-716	Add 7-16 DIN output to any junction			\$108.55

EZ-MATCH

Standard connectors are N-Female. DIN-F optional.

MODEL	DESCRIPTION	FREQ. RANGE	TX POWER	GSA PRICE
TZM-50	E-Z Match - Transmitter to Load	30-54 MHz	400 Watts	\$98.90
TZM-150	E-Z Match - Transmitter to Load	144-174 MHz	400 Watts	\$98.90
TZM-450	E-Z Match - Transmitter to Load	400-512 MHz	400 Watts	\$98.90
TZM-860	E-Z Match - Transmitter to Load	800-960 MHz	400 Watts	\$98.90

SECTION 7**CABLES AND CONNECTORS****CABLE ASSEMBLIES**

MODEL	CABLE / CONNECTORS	GSA PRICE		
		2' (0.6m)	5' (1.5m)	10' (3.0m)
ANTA-01- (2) (5) (10)	RG-213/U UHF Male - UHF Male	\$25.45	\$27.08	\$32.82
ANTA-02- (2) (5) (10)	RG-213/U N Male - N Male	\$23.69	\$28.72	\$33.65
ANTA-03- (2) (5) (10)	RG-213/U N Male - N Female	\$23.69	\$28.72	\$33.65
ANTA-04- (2) (5) (10)	RG-213/U N Female - N Female	\$23.69	\$28.72	\$33.65
ANTA-05- (2) (5) (10)	RG-213/U N Male - UHF Male	\$23.69	\$27.08	\$33.65
ANTA-06- (2) (5) (10)	RG-213/U N Female - UHF Male	\$23.69	\$27.08	\$33.65
ANTB-01- (2) (5) (10)	RG-214/U N Male - N Male	\$30.35	\$43.51	\$52.52
ANTB-03- (2) (5) (10)	RG-214/U N Male - N Female	\$30.35	\$43.51	\$52.52
ANTB-04- (2) (5) (10)	RG-214/U N Female - N Female	\$30.35	\$43.51	\$52.52
ANTB-05- (2) (5) (10)	RG-214/U N Male - UHF Male	\$30.35	\$43.51	\$52.52
ANTB-06- (2) (5) (10)	RG-214/U N Female - UHF Male	\$30.35	\$43.51	\$52.52
ANTD-01- (2) (5) (10)	RG-142B/U UHF Male - UHF Male	\$28.88	\$41.04	\$50.06
ANTD-03- (2) (5) (10)	RG-142B/U N Male -N Male	\$28.88	\$41.04	\$50.06
ANTD-04- (2) (5) (10)	RG-142B/U N Male - N Female	\$28.88	\$41.04	\$50.06
ANTD-08- (2) (5) (10)	RG-142B/U N Female - N Female	\$28.88	\$41.04	\$50.06
ANTD-09- (2) (5) (10)	RG-142B/U N Male - UHF Male	\$28.88	\$41.04	\$50.06
ANTD-10- (2) (5) (10)	RG-142B/U N Female - UHF Male	\$28.88	\$41.04	\$50.06
ANTE-01- (2) (5) (10)	RG-393/U 7-16 DIN Male - Male	\$127.37	\$167.43	\$208.46
ANTE-02- (2) (5) (10)	RG-393/U 7-16 DIN Male - R/A Male	\$154.77	\$187.13	\$224.05
ANTE-03- (2) (5) (10)	RG-393/U 7-16 DIN R/A Male - R/A Male	\$175.49	\$217.50	\$232.26

CABLE ASSEMBLY ORDERING INFORMATION

Length in feet follows model number. Example: RG-214, N-male, 5 feet = "**ANTB-03-5**".

Approximate shipping weight: ANTA / ANTB / ANTE = 0.5 lb (0.2 kg) per ft. ANTD = 0.25 lb (0.1 kg) per ft.

MODEL	DESCRIPTION	GSA PRICE
TW2	Custom Jumper cables - Contact factory for pricing	
CBL213	RG-213 Type coaxial cable, per foot	\$1.23
CBL214T	RG-214T Coaxial cable per foot	\$1.90
TRG214	RG-214 Coaxial cable, per foot, Mil Spec, Silver Plate	\$7.29
TSFXC	FSJ4-50B 1/2" Superflex cable, per foot (not assembled)	\$6.96
UG21-SFX	Male Connector for Superflex. Gold plated pin. (Quantity pricing avail.)	\$11.48
TWEMMS	"Short" elbow adaptor N-Male to N-Male (CO038) 1-3/8" L	\$17.23
TWEMML	"Long" elbow adaptor N-Male to N-Male (CO039) 1-5/8" L	\$17.23

NOTES:

- 1) Custom cables available, and connectors can be supplied loose to allow critical-length cutting in the field.
- 2) Prices subject to change without notice based on availability and precious metal content.