

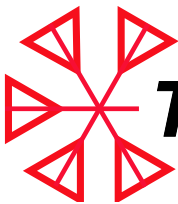

# Model 44L1/L1P BROADBAND RF WATT METER

OPERATION MANUAL



***TELEWAVE, INC.***



## MODEL 44L1/L1P BROADBAND RF WATTMETER DESCRIPTION AND OPERATION

<b>CONTENTS</b>	<b>PAGE</b>
1. SPECIFICATIONS	2
2. GENERAL DESCRIPTION	3
3. PHYSICAL DESCRIPTION	5
4. FUNCTIONAL DESCRIPTION	
Schematic and Parts List	6
Functional Description	7
Accessory List	8
5. OPERATION	
Unpacking and Connections	9
Power Measurements	10
VSWR Calculations	11
True Power at Load Calculation	11
Directivity and Insertion Error	12
6. MAINTENANCE	
Warranty Service and Calibration	13
Parts Location	14
Calibration / Adjustment Procedure	15
7. REFERENCE	
VSWR Nomograph	17
Jumper Cable Cutting Chart	18

# 1 SPECIFICATIONS

**1.01** Table 1-1 lists specifications for the Telewave Model 44L1/L1P Broadband RF Wattmeter. These are provided to assist the user in formulating acceptance criteria, determining applications, and for periodic recalibration of the instrument. Minor deviations from these specifications which do not affect performance of the Model 44L1/L1P Wattmeter should not be considered a warranty issue.

**Table 1-1: Model 44L1/L1P RF Wattmeter Specifications**

<b>Parameter</b>	<b>Characteristics</b>
Frequency Range Accuracy	2 to 200 MHz ± 7 percent of full scale (Specified with N connectors only)
Power Ranges	5, 15, 50, 150 and 500 Watts
Primary Line Impedance VSWR Insertion Loss	50 Ohms nominal 1.1 maximum 0.1 dB maximum
RF Sample Port (44L1P)	-40 dB +/- 2 dB
RF Connectors Standard Optional	QC - "Quick-Change" type N-Female UHF, BNC, TNC, 7-16 DIN M/F
Dimensions Height Width Depth Weight	6.625 in. (16.83 cm) 4 in. (10.16 cm) 3.25 in. (8.26 cm) 3 lb. (1.36 kg)

## 2 GENERAL DESCRIPTION

**2.01** This manual provides the physical and functional description and operating theory necessary for effective use of the Telewave Model 44L1/L1P Broadband Radio Frequency (RF) Wattmeter. Its features include:

- Displays five power ranges
- Measures 1 to 500 watts
- Does not require inserts
- Does not require band switching
- Fully operable in freezing conditions
- Provides 5 watts full scale range
- Interchangeable connectors (QC)
- Lightweight, rugged and easy to carry
- -40 dB RF sampling port (Model 44L1P)

**2.02** The instrument integrates two broadband directional couplers for measuring incident and reflected power, ranging, calibration and display. The wide coverage and dynamic range of this instrument eliminates any inserts or band switching. A 20  $\mu$ A taut band meter movement is used to display the measured power, providing the measurement accuracy necessary to tune low power portable transmitters.

**2.03** A convenient, easy to read, voltage standing wave ratio (VSWR) chart is provided on the rear of the instrument for determining VSWR from the measured incident and reflected power levels. The instrument is designed for rugged field use and is housed in a diecast metal case with a leather carrying strap. The measurement circuits in the wattmeter are driven directly by the current developed in the coupler, making it unnecessary to supply AC power or batteries. A carrying case (Model TC44) is available as an option. The Model 44L1/L1P is ideally suited for mobile, marine, and aircraft applications as well as base stations.

Telewave, Inc.  
Model 44L1/L1P

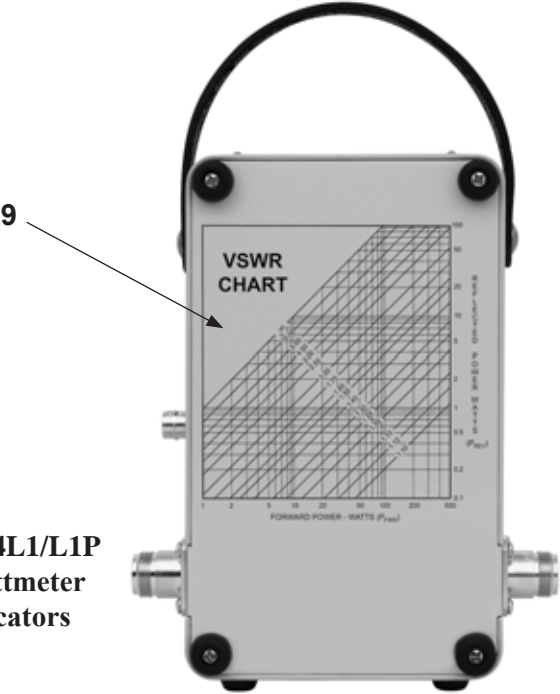
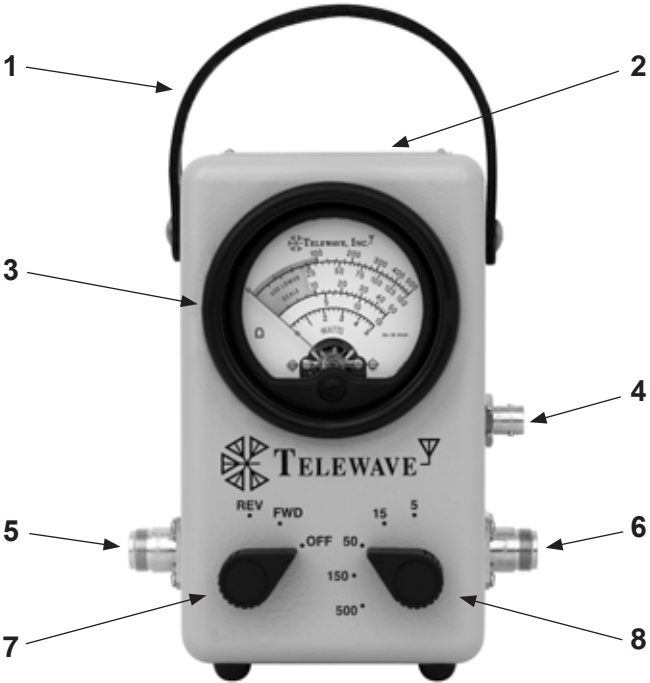

**Figure 2-1: Model 44L1/L1P  
Broadband RF Wattmeter  
Controls and Indicators**

### 3 PHYSICAL DESCRIPTION

**3.01** The controls and indicators of the Model 44L1/L1P Broadband RF Wattmeter are illustrated in Figure 2-1, and the functions of these elements are described in Table 3-1.

**Table 3-1 : Model 44L1/L1P Description**

Key	Item	Description
1	Carry Strap	For carrying or hanging the instrument.
2	Identification Label	Contains model and serial number of the instrument.
3	Meter	Displays measured power.
4	Sample Port	Connection point for external measurement or signal injection (Model 44L1P).
5	Input Connector	Connection point for the RF source, such as an RF power amplifier or transmitter. Mates with Type N or UHF connector (typical).
6	Output Connector	Connection for the RF load, such as an antenna or dummy load. Mates with Type N or UHF connector (typ.)
7	Mode Switch	(1) OFF – Transit. Provides protection for meter during instrument movement. (2) FWD – Displays forward or incident power. (3) REV – Displays the reflected power.
8	Power Range Switch	Selects one of 5 full scale power ranges.
9	VSWR Chart	Provides a method to calculate VSWR from the measured forward and reflected power.

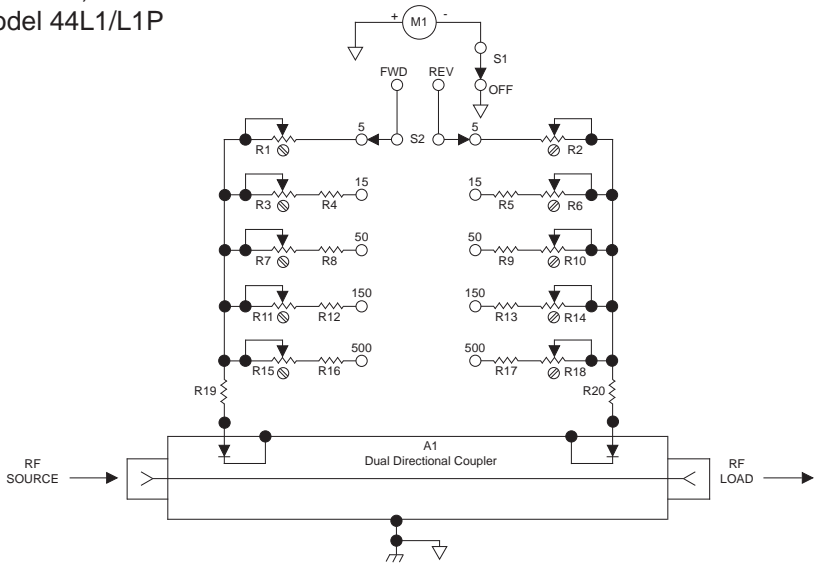

**Figure 3-1: Model 44L1/L1P RF Wattmeter Schematic**

**Table 3-2 : Model 44L1/L1P Parts List**

REF	DESCRIPTION	MFG	MFG P/N
M1	METER: 20 UA	TRIPLETT	7034
MP1	KNOB	RAYTHEON	MS-91528-1P2B
MP2	SCREW: BUMPER 6-32	TELEWAVE	TB44
MP6	STRAP: LEATHER	TELEWAVE	HH44
MP8	SCREW: TRUSS HEAD 10-52	ICO-RALLY	SCR-813
MP9	SHOCK RING: EDM	TELEWAVE	7099
QC	N FEMALE CONNECTOR	TELEWAVE	QC44N
QC	UHF FEMALE CONNECTOR	TELEWAVE	QC44S
QC	BNC FEMALE CONNECTOR	TELEWAVE	QC44B
QC	TNC FEMALE CONNECTOR	TELEWAVE	QC44T
QC	7-16 DIN FEMALE CONNECTOR	TELEWAVE	QC44D
R1	RESISTOR: VAR CC 0.25W 10% 50K OHM		
R2	RESISTOR: VAR CC 0.25W 10% 50K OHM		
R3	RESISTOR: VAR CC 0.25W 10% 50K OHM		
R4	RESISTOR: FXD CC 0.50W 5% 7.5K OHM		
R5	RESISTOR: FXD CC 0.50W 5% 7.5K OHM		
R6	RESISTOR: VAR CC 0.25W 10% 50K OHM		
R7	RESISTOR: VAR CC 0.25W 10% 50K OHM		
R8	RESISTOR: FXD CC 0.50W 5% 62K OHM		
R9	RESISTOR: FXD CC 0.50W 5% 62K OHM		
R10	RESISTOR: VAR CC 0.25W 10% 50K OHM		
R11	RESISTOR: VAR CC 0.25W 10% 100K OHM		
R12	RESISTOR: FXD CC 0.50W 5% 130K OHM		
R13	RESISTOR: FXD CC 0.50W 5% 130K OHM		
R14	RESISTOR: VAR CC 0.25W 10% 100K OHM		
R15	RESISTOR: VAR CC 0.25W 10% 100K OHM		
R16	RESISTOR: FXD CC 0.50W 5% 300K OHM		
R17	RESISTOR: FXD CC 0.50W 5% 300K OHM		
R18	RESISTOR: VAR CC 0.25W 10% 100K OHM		
R19	RESISTOR: FXD CC 0.25W 5% 51 OHM		
R20	RESISTOR: FXD CC 0.25W 5% 51 OHM		
S1, 2	SWITCH: ROTARY 2 POLE 5 POS	ELECTROSWITCH	D3G0205N-4096

## 4 FUNCTIONAL DESCRIPTION

- 4.01** The Model 44L1/L1P Wattmeter is made up of two major sections. Refer to the schematic diagram in Figure 3-1 for this description.
- (a) A Dual RF Directional Coupler with directivity of greater than 25 dB.
  - (b) A voltmeter circuit. Five ranges are provided.
- 4.02** The 50 ohm Dual Directional Coupler A1 samples a small amount of the incident or forward RF power delivered to the load. The coupler incorporates two RF detectors which produce a DC voltage proportional to the sampled RF power. A small amount of power reflected from the load is also sampled.
- 4.03** Mode Switch S1 determines which of these voltages is displayed on the meter, M1. The RF Power Range Switch S2, selects the appropriate range and calibration resistors for the power to be measured. Each range is provided with an adjustable internal potentiometer for range calibration.
- 4.04** Meter M1 displays five scales which correspond to the RF Power Range Switch positions. The lower third of the meter scale is shaded red, alerting the user to switch to a lower power range for improved accuracy. An OFF position is provided on Mode Switch S1, which shunts out the meter movement. This provides protection for the sensitive meter when the instrument is being transported.
- 4.05** Model 44L1P provides an RF sampling port with an output of -40 dB (+/- 2 dB) below the transitional line level to use for measurement of frequency, spectrum analysis, to inject a signal for measurement of receiver sensitivity, or other applications. The port coupling is not directional; in a high VSWR system, the sampling port output will be -40 dB below the *total* power passing through the instrument.



### Optional Accessories

**4.06** The table below lists the most common accessories for the Model 44L1/L1P Wattmeter. Consult the current price list or our website for current pricing.

Part Number	Description
TC44	Leather carry case with accessory pouch
TWL-35	Coaxial Dry Load - 35 watts
TWL-50	Coaxial Dry Load - 50 watts
TWL-60	Coaxial Dry Load - 60 watts
TWL-75	Coaxial Dry Load - 75 watts
TWL-100	Coaxial Dry Load - 100 watts
TWL-150	Coaxial Dry Bench Load - 150 watts
TWL-300	Coaxial Dry Bench Load - 300 watts
QC44B	Quick Change BNC-female connector
QC44D	Quick Change 7-16 DIN-female connector
QC44N	Quick Change N-female connector
QC44S	Quick Change UHF-female connector
QC44T	Quick Change TNC-female connector
ANTA-02-5	Jumper - RG-213/U, 5 ft., N-Male
ANTD-03-5	Jumper - RG-142B/U, 5 ft., N-Male



**Figure 4-1: Optional TC44 Carrying Case and RF Loads**

## 5 OPERATION

### Unpacking

- 5.01** After the Model 44L1/L1P Wattmeter arrives, examine the shipping container for visible loss or damage. Carefully unpack the wattmeter and examine the exterior for damage.

#### IMPORTANT

*The Model 44L1/L1P Wattmeter is carefully tested, inspected, and packed before leaving the Telewave factory. Claims for loss or damage sustained in transit should be made upon the carrier, NOT TO Telewave, Inc., as follows:*

- (1) Visible Loss or Damage - Any evidence must be noted on the freight bill or express delivery sheet. The form required to file such a claim will be supplied by the carrier.*
- (2) Concealed Loss or Damage - This damage does not become evident until after the wattmeter is unpacked. When the damage is discovered, make a written request for inspection by the carrier's agent within fifteen (15) days of the delivery date. File a claim with the carrier.*

### RF Connections

- 5.02** The following procedure will assist the user in preparation for making an RF power measurement. Refer to Figure 2-1.

Step	Procedure
1	Remove the RF power from the transmission line.

<b>Step</b>	<b>Procedure</b>
2	Set the RF Range Switch to the 500 Watt position.
3	Connect the RF Source to the Model 44L1/L1P FWD input connector, located on the left side of the instrument nearest the mode switch.
4	Connect the RF Load to the Model 44L1/L1P FWD output connector, located on the right side of the instrument nearest the range switch.

### **Forward Power Measurement**

**5.03** The following procedure will assist the user in making an incident or forward power measurement. Refer to Figure 2-1.

<b>Step</b>	<b>Procedure</b>
1	Set the Mode Switch to the FWD position.
2	Apply RF power to the transmission line.
3	Move the RF Range Switch to a lower range if necessary to obtain a reading in the upper third of the scale.
4	Note the meter reading.

### **Reflected Power Measurement**

**5.04** The following procedure will assist the user in making a reflected or reverse power measurement.

<b>Step</b>	<b>Procedure</b>
1	Set the Mode Switch to the REV position.
2	Repeat Step 2 of 5.03.
3	Repeat Step 3 of 5.03.

## VSWR Calculation

**5.05** The following procedure will assist the user in determining the Voltage Standing Wave Ratio.

Step	Procedure
1	Perform the procedures outlined in 5.03 and 5.04. Record the true incident and reflected power.
2.	Refer to the VSWR Chart on the rear of the instrument or Figure 7-1. Apply the readings from Step 1 to the chart.
3.	<p>The VSWR is read from the nearest sloping line. For higher accuracy, calculate the VSWR by the formula:</p> $\text{VSWR} = \frac{1 + \sqrt{\frac{P_{\text{REV}} \text{ (Watts)}}{P_{\text{FWD}} \text{ (Watts)}}}}{1 - \sqrt{\frac{P_{\text{REV}} \text{ (Watts)}}{P_{\text{FWD}} \text{ (Watts)}}}}$

## True Power at Load Calculations

**5.06** The following procedure will assist the user in determining the actual power delivered to the load.

Step	Procedure
1	Perform the procedures outlined in 5.03 and 5.04. Record the true incident and reflected power.
2	Subtract the reflected power from the incident power. This difference is the true power at the load.

### **Directivity Error**

**5.07** Directivity error results from the effect of imperfect directivity in the Dual Directional Coupler. Directivity is the ability of the coupler to sense power flowing in one direction and be insensitive to any power which may be flowing in the reverse direction. The directivity error is included within the specified instrument accuracy.

### **Insertion Error**

**5.08** When the RF load and RF source are well matched, any error contributed by inserting the Model 44L1/L1P Wattmeter alone is negligible. However, the use of a jumper cable to connect the wattmeter in the system will change the characteristic impedance of the line, especially in a system with high VSWR. Since the impedance on either side of  $1/2$  wavelength is identical, the jumper cable added to the input or output of the Model 44L1/L1P should be of an appropriate length to equal  $1/2$  wavelength at the frequency of operation, thus eliminating any error due to the additional length.

**5.09** The chart shown in Figure 7-2 shows the required length (including connectors) of RG-213/U cable to act as a  $1/2$  wave line section at frequencies from 25-200 MHz.

## **6 MAINTENANCE**

**6.01** The Model 44L1/L1P Wattmeter is designed with high reliability components and operates on low DC power levels. It can be expected to operate at peak performance for long intervals. Periodic calibration by Telewave or an RF standard laboratory is recommended to maintain peak instrument performance.

### **Warranty Service**

**6.02** The Model 44L1/L1P Wattmeter is covered under Telewave's standard 1 year warranty. See the inside back cover for exact terms. Faulty units should be returned to:

**Telewave, Inc.  
ATTN: Repairs  
660 Giguere Court  
San Jose, CA 95133  
1-800-331-3396 / +1 408-929-4400**

**6.03** A Return Material Authorization (RMA) is required when products are returned to Telewave. The following information will be requested in order to assign an RMA:

- The Model 44L1/L1P serial number. The ID plate is located on the top of the instrument. Include the date of purchase and Purchase Order number if known.
- A brief statement of the problem.
- Contact name, telephone number, and return shipping address.

### **Calibration**

**6.04** Adjustments to the instrument should be performed by Telewave, or other RF calibration laboratory. Calibration or adjustment should be made at a frequency of 100 MHz when possible. The adjustment potentiometers are located on the main PC board inside the instrument. Refer to Figure 3-1 and 6-1.

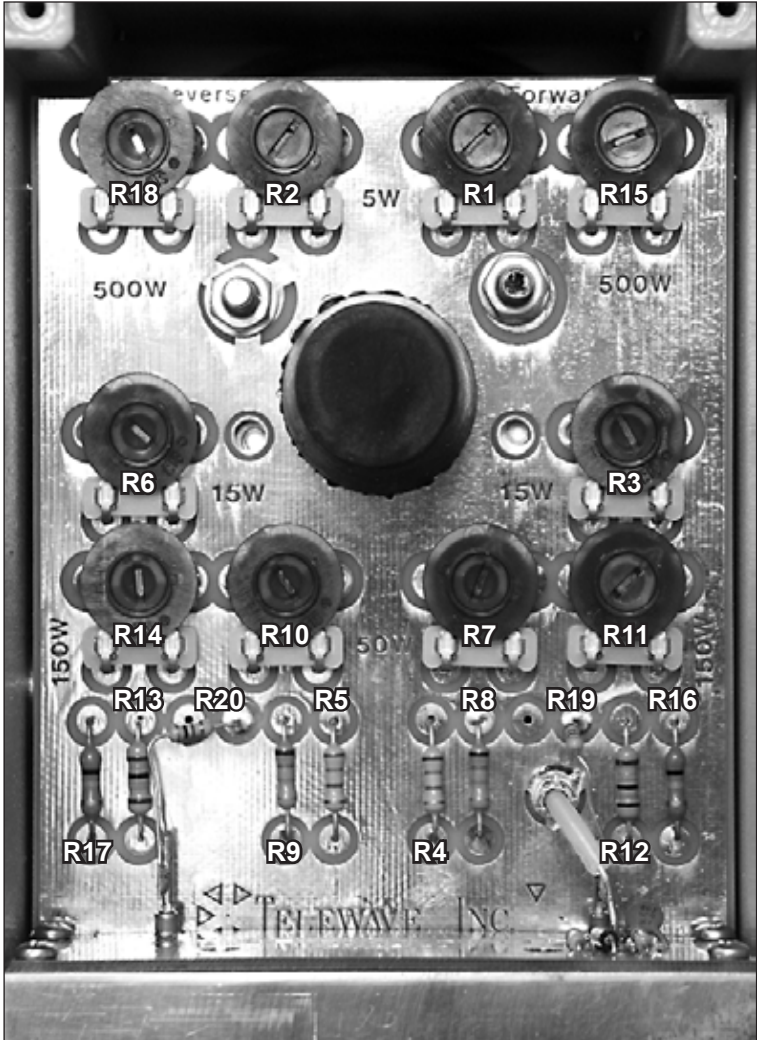

**Figure 6-1: Adjustment Potentiometers and Parts Location**

REVERSE RANGES	
R2	5 watt range
R6	15 watt range
R10	50 watt range
R14	150 watt range
R18	500 watt range

FORWARD RANGES	
R1	5 watt range
R3	15 watt range
R7	50 watt range
R11	150 watt range
R15	500 watt range

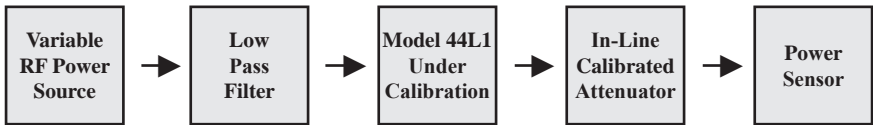

**Figure 6-2: Calibration / Adjustment Equipment Setup**

### **6.05 Calibration / Adjustment Requirements and Equipment**

- a) The ambient temperature during calibration must be 72.4 degrees.
- b) The Telewave meter must be calibrated in the intended operating position, either vertical or horizontal. Meters are calibrated by Telewave in the vertical position.
- c) The Telewave wattmeter and any interconnections must use only Type N connectors.
- d) An RF power source capable of producing at least 325 watts continuous power at 100 Mhz.
- e) A low pass filter capable of handling at least the maximum continuous power used during calibration must be installed between the RF source and the Telewave meter.
- f) A calibrated digital power meter and remote sensor, with accuracy of +/- 0.5% or better, traceable to NIST. Insertion loss of all test equipment must be characterized.
- g) A 50 ohm inline attenuator capable of handling the maximum continuous power that will be used during calibration.

**Caution: Do not drive the meter beyond full scale, and do not apply more than 500 watts input power at any time.**



**6.06** Remove the four bumper screws from the rear panel. Remove the rear panel. Figure 6-1 illustrates the adjustment locations. Refer to Figure 6-2, Equipment Setup. Perform the calibration / adjustment for Forward and Reverse direction as follows:

**6.07 Forward Mode Adjustment**

Step	Procedure
1a	Set the RF source to 100 MHz.
1b	Set the wattmeter Mode Switch to FWD position.
1c	Set the wattmeter RF Range Switch to the 5 watt range.
1d	Set the RF source to 4 watts output.
1e	Adjust R1 until the Telewave wattmeter reads 4 watts.
2a	Set the wattmeter RF Range Switch to the 15 watt scale.
2b	Set the RF source to produce 11 watts output.
2c	Adjust R3 until the Telewave wattmeter reads 11 watts.
3a	Set the wattmeter RF Range Switch to the 50 watt scale.
3b	Set the RF source to produce 35 watts output.
3c	Adjust R7 until the Telewave wattmeter reads 35 watts.
4a	Set the wattmeter RF Range Switch to the 150 watt scale.
4b	Set the RF source to produce 105 watts output.
4c	Adjust R11 until the Telewave wattmeter reads 105 watts.
5a	Set the wattmeter RF Range Switch to the 500 watt scale.
5b	Set the RF source to produce 325 watts output.
5c	Adjust R15 until the Telewave wattmeter reads 325 watts.

**6.08 Reverse Mode Adjustment**

6a	Disable the RF source output
6b	Set the wattmeter Mode Switch to REV position.
6c	Reverse the wattmeter RF connections in the RF line.
6d	Repeat Steps 1c through 5c for the 5, 15, 50, 150 and 500 watt ranges, using adjustment points R2, R6, R10, R14, and R18.
6e	Reinstall the rear panel and bumper screws.

## 7 REFERENCE

- 7.01** Part 7 contains additional data for the Model 44L1/L1P RF Wattmeter which is helpful in making low frequency and VSWR measurements.
- 7.02** Figure 7-1 (below) shows a nomograph for estimating VSWR from the measured incident and reflected power. See 5.05 for calculation procedures.

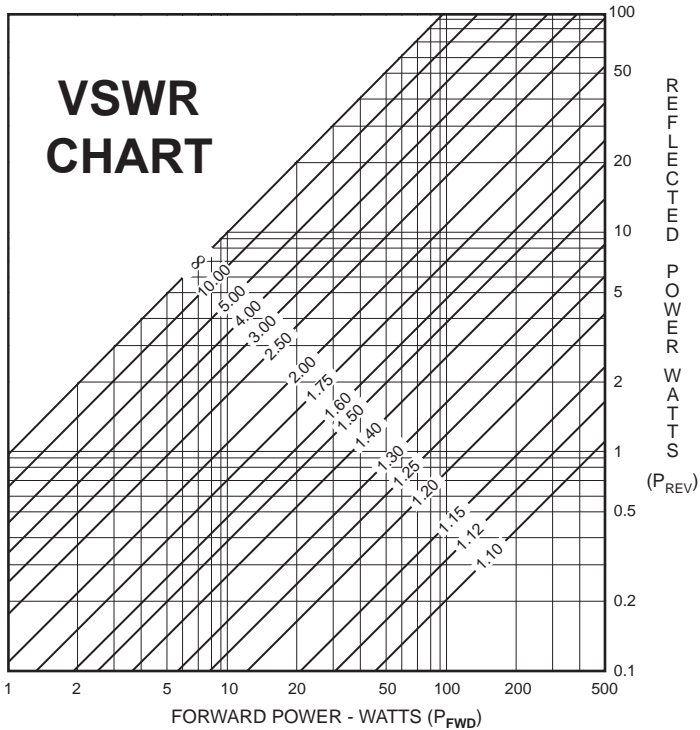

**Figure 7-1: VSWR Chart**

**7.03** Figure 7-2 shows a chart for a jumper cable to be used inline with the Model 44L1/L1P Wattmeter to minimize potential measurement errors in systems with high VSWR. The chart shows lengths for a 50-ohm, RG-213 jumper cable, including N connectors, using a velocity factor of 0.66 for the cable and connectors. The jumper cable *and* wattmeter together should equal as close to 1/2 wavelength equivalent as possible, at the test frequency.

MHZ	INCHES	MHZ	INCHES
25	= 153.23	115	= 31.24
30	= 127.25	120	= 29.83
35	= 108.69	125	= 28.53
40	= 94.78	130	= 27.33
45	= 83.95	135	= 26.22
50	= 75.29	140	= 25.19
55	= 68.21	145	= 24.23
60	= 62.30	150	= 23.34
65	= 57.31	155	= 22.50
70	= 53.03	160	= 21.71
75	= 49.32	165	= 20.98
80	= 46.07	170	= 20.28
85	= 43.20	175	= 19.63
90	= 40.66	180	= 19.01
95	= 38.38	185	= 18.42
100	= 36.33	190	= 17.87
105	= 34.47	195	= 17.34
110	= 32.78	200	= 16.84

**Figure 7-2: RG-213 Jumper Cable with N-Male Connectors**

# PRODUCT WARRANTY

Products sold by Telewave, Inc. and covered by this Warranty are warranted to be free from defects in material and workmanship at the time of and for a period of one (1) year after delivery to the Buyer. Seller's entire warranty obligation is limited to making adjustments by repair, replacement, or refunding the purchase price of any product which is returned to the Seller as provided below within one (1) year from the date of shipment by the Seller. In no event shall Seller be liable for direct, special, or consequential damages for breach of warranty.

Adjustment will not be allowed for products which have been damaged by lightning, subjected to abuse, improper application or installation, alteration or accident, or negligence in use, storage, transportation or handling. Alteration or removal of the serial number or identification markings voids the Warranty. Seller shall have the right of final determination as to the existence and cause of a defect, whether adjustment will be allowed, and if allowed, whether adjustment will be by repair, replacement, or refund. Where adjustment is not allowed, a charge of 5% of the original purchase price will be made to the Buyer to cover the Seller's cost of inspection and handling.

Shipping and packaging instructions must be obtained from the Seller before products are returned for adjustment. The Buyer will pay for packing, transportation, and transit insurance costs for returned products. The Seller reserves the right to discontinue models at any time or change specifications, design, or price without notice and without incurring any obligation. Products will be returned to the Buyer with transportation cost collect.

Subject to the provisions of its "Patent Indemnity" clause, the Seller also warrants that it has the right to sell its products, that the Buyer shall have and enjoy quite possession thereof as against any lawful claims existing at the time of the sale by the Seller, and that said products are free from any charge of encumbrance in favor of third persons existing at the time of sale by the Seller.

The foregoing constitutes the Seller's entire warranty, express, implied or statutory with respect to its products and states the full extent of its liability for breach of Warranty and for damages, whether direct, special or consequential resulting from any such breach. No change whatsoever thereto shall be binding upon the seller unless made in writing and signed by a duly authorized representative of the Seller.

**TELEWAVE, INC.**  
660 Giguere Court  
San Jose, CA 95133 USA  
1-800-331-3396  
+1 408-929-4400